



CATÁLOGO 2023

INGCO

Make The World In Your Hands





5 - 21



HERRAMIENTA ELÉCTRICA

22 - 46

Atornilladores	Martillos combinados y demolidores	Amoladoras
Gama Maquinas 20V	Caladoras y Sierras	Pantallas de Soldar
Baterías y Cargadores	Tronzadoras	Pistolas
Taladros percutores	Aspiradores	
Lijadoras		

MOTOBOMBAS

47 - 49

Motobombas Gasolina
Bombas Sumergibles
Limpiadoras alta presión y accesorios

50 - 51

GENERADORES

CONSUMIBLES

52 - 66

Brocas y porta brocas	Discos
Punteros y cinceles	Coronas
Sierras	Clavos y Grapas
Lijas	Pilas Alcalinas

HERRAMIENTA MANUAL

67 - 110

Maletas	Paletas y llanas	Cutters
Cajas de Herramientas	Sargentos	Espátulas
Portaherramientas	Tornillos de Banco	Escuadras magnéticas
Alicates	Destornilladores	Pistolas mortero y silicona
Tenazas	Juegos de llaves	Remachadoras
Martillos y Mazas	Corta varillas	
Cinceles	Sierras	

HERRAMIENTAS DE MEDICIÓN

111 - 117

Flexómetros	Niveles
Medidores laser	Detectores de corriente

118 - 120

HERRAMIENTA NEUMÁTICA/TALLER

121 - 122

LINTERNAS

123 - 125

HERRAMIENTA JARDÍN

126 - 128

HERRAMIENTAS PINTOR

132 - 156



WIZARCS

POWER FOR WARRIORS



POWER FOR WARRIORS

CATÁLOGO DE PRODUCTOS

BOOST 185

SKU | WRB-185-DCE

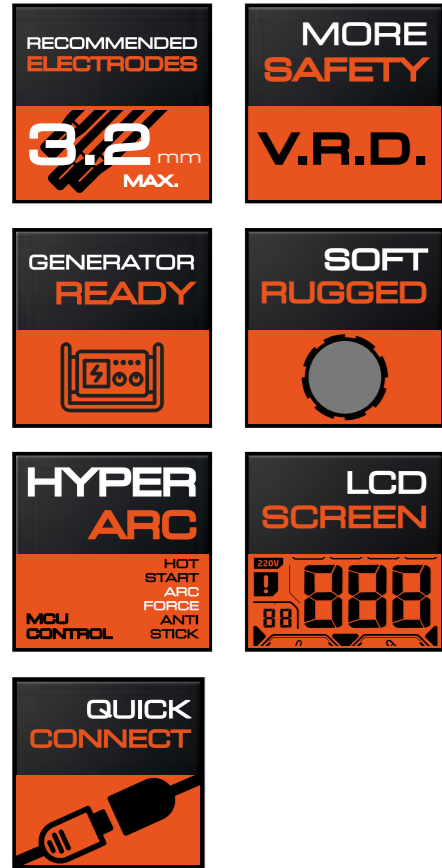

- 1.- Electrodos de hasta Ø 3.2mm.
- 2.- Sistema de seguridad V.R.D. (Voltage Reduction Device), reduce el riesgo de choque eléctrico.
- 3.- Puede conectarse a Generadores.
- 4.- Perilla en Goma, para un mejor agarre con guantes.
- 5.- HYPER-ARC, con HOT START, ARC FORCE y ANTI-STICK.
- 6.- Pantalla LCD de alto contraste.
- 7.- Conectores rápidos tipo DINSE 10/25.



BOOST 185

EAN 7503034761211

REF. BOOST 185

PVP: 133,70 €

VERSATILIDAD CON PODER

Soldador portátil con la tecnología más moderna, para llevar a cualquier lugar.

BOOST te ofrece toda la potencia para afrontar los retos diarios, con capacidad para electrodos de hasta 3.2mm y sobresaliente para 2.5mm.

HYPERARC ofrece un control electrónico del arco, para una estabilidad superior.

Preparada para trabajar con generadores a 230V, con una potencia mínima de 5.0Kw nominal.



**Soldando 013,7018,6011
INOXIDABLES Y FUNDICIONES**

INFORMACIÓN RÁPIDA

TAMAÑO	PESO	POTENCIA	CONEXIÓN	ELECTRODOS
MINI SIZE	2.2KG	150A	230v	MAX 3.2mm RECOMENDADO 2.5mm

WIZARCS

BOOST 185

CONEXIÓN	230V - 50/60 Hz +/-10%
RANGO DE AMPERAJE	10-150A
CICLO DE TRABAJO A 40°C	50%
VOLTAJE EN VACIO UO	10-150A
MODOS	MMA / TIG
TIPO DE TIG	LIFT ARC
CONECTORES	RÁPIDOS DE 9mm
IP	IP21 S
TIPO DE PANTALLA	LCD UNI-COMMAND
PERILLA	GRAN TAMAÑO - SOFT TOUCH
GENERADORES	CONECTABLE A GENERADORES (4.5 KW - 220V)
EXTENSIONES (ENTRADA)	Hasta 10m - AWG10
EXTENSIONES (SALIDA)	Hasta 10m - AWG4

CONTACT 205

SKU | WRB-205-DCE



RECOMMENDED
ELECTRODES

3.2 mm
MAX.

**MORE
SAFETY**

V.R.D.

GENERATOR
READY

**SOFT
RUGGED**

**HYPER
ARC**

HOT
START
ARC
FORCE
ANTI
STICK
MCU
CONTROL

**LCD
SCREEN**

**QUICK
CONNECT**

- 1.- Electrodo de hasta Ø 3.2mm.
- 2.- Sistema de seguridad V.R.D. (Voltage Reduction Device), reduce el riesgo de choque eléctrico.
- 3.- Puede conectarse a Generadores.
- 4.- Perilla en Goma, para un mejor agarre con guantes.
- 5.- HYPER-ARC, con HOT START, ARC FORCE y ANTI-STICK.
- 6.- Pantalla LCD de alto contraste.
- 7.- Conectores rápidos tipo DINSE 10/25.



CONTACT 205

EAN 7503034761228

REF. CONTACT 205

PVP: 187,94 €

RENDIMIENTO ÓPTIMO
Diseñada para el trabajo diario

CONTACT te ofrece toda la potencia para afrontar los retos diarios, con capacidad para electrodos de hasta 4.0mm

y sobresaliente para 3.2mm.

HYPERARC ofrece un control electrónico del arco, para una estabilidad superior.

Preparada para trabajar con generadores a 230V, con una potencia mínima de 6.5Kw nominal.

Puede Soldar E-6010, E 6011, E 6013 E 7018 FUNDICIONES ACEROS INOXIDABLES ALUMNIOS Y RECUBRIMIENTOS DUROS



INFORMACIÓN RÁPIDA

TAMAÑO	PESO	POTENCIA	CONEXIÓN	ELECTRODOS
MINI SIZE	4.0KG	180A	230v	MAX 4.0mm RECOMENDADO 3.2mm

WIZARCS

CONTACT 205

CONEXIÓN	230V - 50/60 Hz +/-10%
RANGO DE AMPERAJE	10-180A
CICLO DE TRABAJO A 40°C	50%
VOLTAJE EN VACIO UO	10-180A
MODOS	MMA / TIG
TIPO DE TIG	LIFT ARC
CONECTORES	RÁPIDOS DE 3/8" (9mm)
IP	IP21S
TIPO DE PANTALLA	LCD UNI-COMMAND
PERILLA	GRAN TAMAÑO - SOFT TOUCH
GENERADORES	CONECTABLE A GENERADORES (6.5 KW - 220V)
EXTENSIONES (ENTRADA)	Hasta 10m - AWGB
EXTENSIONES (SALIDA)	Hasta 10m - AWG2

CONTACT 255

SKU | WRB-255-DCE

- RECOMMENDED ELECTRODES**
4.0
(3/16") MAX.
- MORE SAFETY**
V.R.D.
- GENERATOR READY**
- SOFT RUGGED**
- HYPER ARC**
HOT START
ARC FORCE
ANTI STICK
MCU CONTROL
- LCD SCREEN**
- QUICK CONNECT**



- 1.- Electrodo de hasta Ø 4.0mm.
- 2.- Sistema de seguridad V.R.D. (Voltage Reduction Device), reduce el riesgo de choque eléctrico.
- 3.- Puede conectarse a Generadores.
- 4.- Perilla en Goma, para un mejor agarre con guantes.
- 5.- HYPER-ARC, con HOT START, ARC FORCE y ANTI-STICK.
- 6.- Pantalla LCD de alto contraste.
- 7.- Conectores rápidos tipo DINSE 35/5



CONTACT 255

EAN 7503034761235

REF. CONTACT 255

PVP: 217,48 €

TODO EL PODER
Potencia para todo el día
y para todos los trabajos.

CONTACT te ofrece toda la potencia para afrontar los retos diarios, con capacidad para electrodos de hasta 5.0mm y sobresaliente para 4.0mm.

HYPERARC ofrece un control electrónico del arco, para una estabilidad superior. Preparada para trabajar con generadores a 230V, con una potencia mínima de 8.5Kw nominal.

Puede Soldar E-6010, E 6011, E 6013 E 7018 FUNDICIONES ACEROS INOXIDABLES ALUMINIOS Y RECUBRIMIENTOS DUROS



INFORMACIÓN RÁPIDA

TAMAÑO	PESO	POTENCIA	CONEXIÓN	ELECTRODOS
BIG SIZE	6.0kg	220A	230v	MAX 5.0mm 4.0mm RECOMENDADO

WIZARCS

CONTACT 205

CONEXIÓN	230V - 50/60 Hz +/-10%
RANGO DE AMPERAJE	10-220A
CICLO DE TRABAJO A 40°C	50%
VOLTAJE EN VACIO UO	10-220A
MODOS	MMA / TIG
TIPO DE TIG	LIFT ARC
CONECTORES	RÁPIDOS DE 1/2" (13mm)
IP	IP21S
TIPO DE PANTALLA	LCD UNI-COMMAND
PERILLA	GRAN TAMAÑO - SOFT TOUCH
GENERADORES	CONECTABLE A GENERADORES (8.5 KW - 220V)
EXTENSIONES (ENTRADA)	Hasta 10m - AWGB
EXTENSIONES (SALIDA)	Hasta 10m - AWG2

INFINITY 160

SKU | WMI-160-DCE

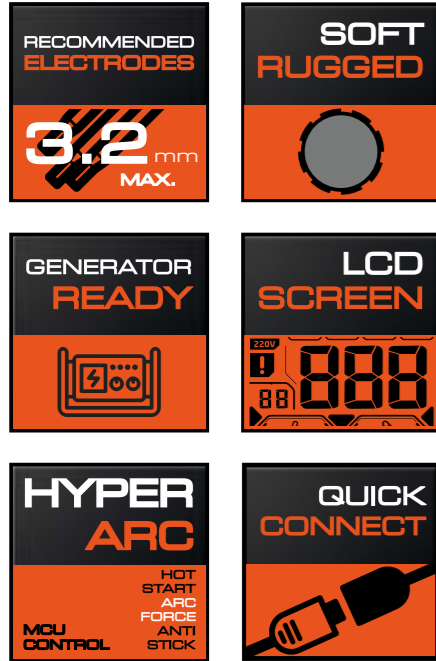

- 1.- Electrodos de hasta Ø 3.2mm.
- 2.- Perilla en Goma, para un mejor agarre con guantes.
- 3.- Puede conectarse a Generadores.
- 4.- Pantalla LCD de alto contraste.
- 5.- HYPER-ARC, con HOT START, ARC FORCE y ANTI-STICK.
- 6.- Conectores rápidos tipo DINSE 35/50.

INFINITY 160

EAN 7503034761242

REF. INFINITY 160

PVP: 285,46 €

CAMBIANDO ESTÁNDARES MULTIPROCESO MIG-MAG / TIG / MMA

INFINITY 160 te ofrece toda la potencia para afrontar los retos diarios, y soldar en 3 procesos, MIG-MAG, TIG Y MMA con capacidad para electrodos de hasta 3.2mm y micro alambre de hasta Ø1.0mm.

DISPLAY LED y control SINÉRGICO, DOBLE PERILLA PARA VOLTAJE, AMPERAJE Y VELOCIDAD MICROALAMBRE.

Preparada para trabajar con generadores a 230V, con una potencia mínima de 6.5KW nominal.



INFORMACIÓN RÁPIDA

TAMAÑO	PESO	POTENCIA	CONEXIÓN	ELECTRODOS	MICROALAMBRE
SMALL SIZE	6.5KG	160A	230V	MAX 3.2mm RECOMENDADO 2.5mm	MAX 1.0mm RECOMENDADO 0.9mm

WIZARCS

INFINITY 160

CONEXIÓN	230V - 50/60Hz +/- 10%
RANGO DE AMPERAJE	25-50A (230V)
CICLO DE TRABAJO A 40°C	50%
VOLTAJE EN VACIO UO	450V
CONECTORES	RÁPIDOS DE (13mm)
IP	IP21S
TIPO DE PANTALLA	LED UNI-COMMAND
PERILLA	GRAN TAMAÑO - SOFT TOUCH
EXTENSIONES (ENTRADA)	Hasta 10m - AWG8
EXTENSIONES (SALIDA)	Hasta 10m - AWG2



INFINITY 220

SKU | WMI-220-DCE

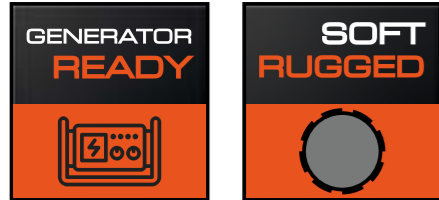

- 1.- Electrodo de hasta Ø 4.0mm.
- 2.- Sistema de seguridad V.R.D. (Voltage Reduction Device), reduce el riesgo de choque eléctrico.
- 3.- Puede conectarse a Generadores.
- 4.- Perilla en Goma, para un mejor agarre con guantes.
- 5.- HYPER-ARC, con HOT START, ARC FORCE y ANTI-STICK.
- 6.- Pantalla LCD de alto contraste.
- 7.- Conectores rápidos tipo DINSE 35/50.



INFINITY 220

EAN 7503034761259

REF. INFINITY 220

PVP: 521,40 €

TRABAJA SIN LÍMITES En todos los procesos

INFINITY 220 te ofrece toda la potencia para afrontar los retos diarios, y soldar en 3 procesos, MIG-MAG, TIG Y MMA con capacidad para electrodos de hasta 4.0mm. y alambre de hasta Ø 1.2mm.

PANTALLA LCD, uni-command, con control de HOT START, ARC FORCE, VRD, indicador de diámetro de electrodo y selección de TIG y ELECTRODO (MMA).

Preparada para trabajar con generadores a 230V, con una potencia mínima de 8.0KW nominal.



INFORMACIÓN RÁPIDA

TAMAÑO	PESO	POTENCIA	CONEXIÓN	ELECTRODOS	MICROALAMBRE
BIG SIZE	11 KG	200A	220V	MAX 4.0mm RECOMENDADO 3.2mm	MAX 1.2mm RECOMENDADO 0.9mm

WIZARCS

INFINITY 160

CONEXIÓN	230V - 50/60Hz +/-10%
RANGO DE AMPERAJE	10-200A
CICLO DE TRABAJO A 40°C	50%
VOLTAJE EN VACIO UO	70V
MODOS	MIG MAG / MMA / TIG LIFT LIFT ARC
TIPO DE TIG	RÁPIDOS DE 1/2" (13mm).
CONECTORES	IP21S
IP	PANTALLA LCD I UNI-COMMAND
TIPO DE PANTALLA PERILLA	GRAN TAMAÑO - SOFT TOUCH
GENERADORES	CONECTABLE A GENERADORES (7.0 KW - 220V)
EXTENSIONES (ENTRADA)	Hasta 10m - AWG8
EXTENSIONES (SALIDA)	Hasta 10m - AWG2
CARRETE (SPOOL)	5KG (Ø200mm.)
TIPO DE ALAMBRE	SOLIDO Y TUBULAR, CON Y SIN GAS

VECTOR 50

SKU | WPV-050-DCE

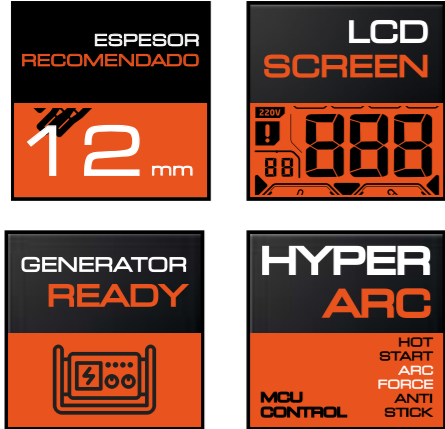

- 1.- Capacidad de corte recomendada de 12mm.
- 2.- Pantalla LED de alto contraste.
- 3.- Puede conectarse a Generadores.
- 4.- HYPER-ARC, con HOT START, ARC FORCE y ANTI-STICK.



VECTOR 50

REF. VECTOR 50

EAN 7503034761266

PVP: 693 €

CALIDAD DE CORTE
Tecnología WIZARCS, en PLASMA

VECTOR te ofrece toda la potencia para afrontar los retos diarios, con capacidad para cortar hasta 20mm en separación y recomendado para 12mm.

Mayor comodidad para trabajar en cualquier lugar, gracias a su conexión de 230V.

HYPERARC ofrece un control electrónico del arco, para una estabilidad superior.

PANTALLA LED de alto contraste.

Preparada para trabajar con generadores a 230V, con una potencia mínima de 8.5Kw nominal.



INFORMACIÓN RÁPIDA

TAMAÑO

PESO

POTENCIA

CONEXIÓN

CAPACIDAD DE CORTE

BIG SIZE

7.5 KG

50A

230 v

MAX
20 mm
12 mm
RECOMENDAD

WIZARCS

INFINITY 160

CONEXIÓN

230V - 50/60Hz +/-10%

RANGO DE AMPERAJE

25-50A (230V)

CICLO DE TRABAJO A 40°C

50%

VOLTAJE EN VACIO U0

450V

CONECTORES

RÁPIDOS DE (13mm)

IP

IP21S

TIPO DE PANTALLA

PANTALLA LCD I UNI-COMMAND

PERILLA

GRAN TAMAÑO - SOFT TOUCH

EXTENSIONES (ENTRADA)

Hasta 10m - AWG8

EXTENSIONES (SALIDA)

Hasta 10m - AWG2

REFLEX 385 ORANGE

SKU | WSR-385

EAN 7503034761174

PVP 33 €

Careta electrónica para soldar de nueva generación, primera en su clase con procesador de señales digitales. Máxima protección para tus ojos.

Amplia área de visión.

Doble sensor digital.

Alimentación híbrida solar y batería (intercambiable).

Procesador ultra rápido Ultra-sensibilidad en baja luminosidad.

Regulación de SOMBRA externa con DIN 9 a 13 y MODO ESMERILADORA.



INFORMACIÓN RÁPIDA

AREA DE VISIÓN



PESO



FILTRO



REACCIÓN



TIG I GTAW



WIZARCS

REFLEX 371

AREA DE VISIÓN	43x93mm / 4.0"
PESO	0.4 Kg
ALIMENTACIÓN	HYBRIDA, SOLAR + BATERÍA REEMPLAZABLE (2032)
TIEMPO DE RESPUESTA	1/25000s.
MODOS	MMA / TIG/MIG
AMPERAJE MÍNIMO	4 AMPS
REGULACIÓN RETARDO	SI, MICROMÉTRICO
REGULACIÓN SENSIBILIDAD	SI, MICROMÉTRICO
REGULACIÓN DE SOMBRA	Variable, DIN 9 A 13, con perilla exterior.
GRINDING	SI, DIN4
TIPO DE VISIÓN	HD A COLOR
MATERIAL	POWER BLAST - PP
NORMAS	ANSI / CSA Z87.1 2010

REFLEX 385 HYPER

SKU | WSR-385-HPR

EAN 7503034761181

PVP: 42,90 €

Careta electrónica para soldar de nueva generación, primera en su clase con procesador de señales digitales. Máxima protección para tus ojos.

Amplia área de visión.

Doble sensor digital.

Alimentación híbrida solar y batería (intercambiable).

Procesador ultra rápido Ultra-sensibilidad en baja luminosidad.

Regulación de SOMBRA externa con DIN 9 a 13 y MODO ESMERILADORA.



INFORMACIÓN RÁPIDA

AREA DE VISIÓN

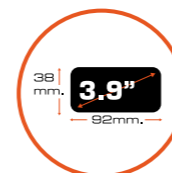

PESO



FILTRO



REACCIÓN



TIG I GTAW



WIZARCS

REFLEX 371

AREA DE VISIÓN	43x93mm / 4.0"
PESO	0.4 Kg
ALIMENTACIÓN	HYBRIDA, SOLAR + BATERÍA REEMPLAZABLE (2032)
TIEMPO DE RESPUESTA	1/25000s.
MODOS	MMA / TIG/MIG
AMPERAJE MÍNIMO	4 AMPS
REGULACIÓN RETARDO	SI, MICROMÉTRICO
REGULACIÓN SENSIBILIDAD	SI, MICROMÉTRICO
REGULACIÓN DE SOMBRA	Variable, DIN 9 A 13, con perilla exterior.
GRINDING	SI, DIN4
TIPO DE VISIÓN	HD A COLOR
MATERIAL	POWER BLAST - PP
NORMAS	ANSI / CSA Z87.1 2010

PREDATOR 700 FLUX

SKU | WSP-700

EAN 7503034302810

PVP 62,54 €

Careta electrónica para soldar de nueva generación, primera en su clase con procesador de señales digitales. Máxima protección para tus ojos.

Amplia área de visión.

Cuatro sensores digitales.

Alimentación híbrida solar y batería (intercambiable).

Procesador ultra rápido Ultra-sensibilidad en baja luminosidad.

Regulación de SOMBRA externa con DIN 9 a 13 y MODO ESMERILADORA.



INFORMACIÓN RÁPIDA

AREA DE VISIÓN



PESO



FILTRO



REACCIÓN



TIG I GTAW



WIZARCS	PREDATOR 700 FLUX
AREA DE VISIÓN	60x101mm / 4.7"
PESO	0.5 Kg
ALIMENTACIÓN	HYBRIDA, SOLAR + BATERÍA REEMPLAZABLE (2032)
TIEMPO DE RESPUESTA	1/300000s.
MODOS	MMA / TIG/MIG
AMPERAJE MÍNIMO	4 AMPS
REGULACIÓN RETARDO	SI, MICROMÉTRICO
REGULACIÓN SENSIBILIDAD	SI, MICROMÉTRICO
REGULACIÓN DE SOMBRA	Variable, DIN 5a 8 y 9 A 13, con perilla exterior.
GRINDING	SI, DIN4
TIPO DE VISIÓN	HD A COLOR
MATERIAL	POWER BLAST - PP
NORMAS	ANSI / CSA Z87.1 2010

ACCESORIOS

Protección exterior WIZARCS Reflex 371/383/383
WSR-383-PRE-P10

Protector exterior PVP: 1,10 €

Protector interior PVP: 0,66 €



Antorcha MIG 150 Infinity
160 WMT-151-INT

PVP: 49,50 €

Antorcha MIG 250 euroconector
WMT-252-INT

PVP: 115,50 €

Hilo para soldar sin gas (fluxcore)
1 kg 0,9 mm (WAM-F01-009)

PVP: 11,38 €

Hilo para soldar sin gas (fluxcore)
5 kg 0,9 mm (WAM-F05-009)

PVP: 57,75 €



HERRAMIENTA ELÉCTRICA

CATÁLOGO 2023

ATORNILLADOR 4V
CSDLI0402

COD 0636
PVP: 21,30 €

- Anclaje hexagonal de 1/4
- Reversible
- Linterna led integrada
- Indicador nivel de batería.
- Incluye portapuntas imantado + 10 puntas



EAN	6925582146950		20 unid.
Voltaje	4V		
Velocidades	180 RPM		
Par	4 Nm		

ATORNILLADOR 4V
CSDLI0403

COD 0637
PVP: 37,60 €

- Anclaje hexagonal de 1/4
- Reversible
- Linterna led integrada
- Indicador nivel de batería.
- Incluye portapuntas imantados + 40 puntas
- Estuche transporte.



EAN	6941640146212		20 unid.
Voltaje	4V		
Velocidades	240 RPM		
Par	4 Nm		

TALADRO ATORNILLADOR 12V
CDLI1232E

COD 0270
PVP: 89,78 €



- Incluye cargador y 2 baterías
- Punta reversible
- Maleta transporte BMC

EAN	6941640108500		5 unid.
Voltaje	12V		
Velocidades	0 - 350 / 0 - 1.250 RPM		
Portabrocas	10 m/m		
Par	20 Nm		
Amperios	1,5Ah		
Posiciones par	18+1		

TALADRO ATORNILLADOR CON PERCUTOR 12V
CIDLI1232E

COD 0353
PVP: 92,99 €



- Incluye cargador y 2 baterías
- Punta reversible y 3 brocas
- Maleta transporte BMC

EAN	6941640127129		5 unid.
Voltaje	12V		
Velocidades	0 - 350 / 0 - 1250 RPM		
Portabrocas	10 m/m		
Par	20 Nm		
Amperios	1,5Ah		
Posiciones par	21+1+1		

TALADRO ATORNILLADOR 20V
CDLI200215

COD 0355
PVP: 145,94 €



- Linterna led integrada
- Punta reversible
- Incluye cargador y 2 baterías de 2Ah
- Maleta transporte BMC

EAN	6941640124678		5 unid.
Voltaje	20V		
Velocidades	0 - 400 / 0 - 1500 RPM		
Portabrocas	10 m/m		
Par	45 Nm		
Amperios	2Ah/4Ah/5Ah		
Posiciones par	15+1		

TALADRO ATORNILLADOR CON PERCUTOR 20V
CIDLI200215

COD 0356
PVP: 153,50 €



- 15 +1 Posiciones par
- Linterna led integrada
- Punta reversible
- Incluye cargador y 2 baterías de 2Ah
- Maleta transporte BMC

EAN	6941640119551		unid.
Voltaje	20V		
Velocidades	0 - 400 / 0 - 1.500 RPM		
Capacidad portabrocas	10 mm		
Par	45 Nm		
Amperios	2Ah/4Ah/5Ah		
Función percutor	0 - 22.500 gpm		

TALADRO ATORNILLADOR CON PERCUTOR BRUSHLES LI-ION

COD 0638

CIDL120608

PVP: 214,28 €

P20S

BL MOTOR



2.0Ah



- Motor sin escobillas
- 23+1+1 Posiciones par
- Linterna led integrada
- Reversible
- Incluye cargador y 2 baterías de 2 Ah
- Bolsa de tela

EAN	6941640155412	5 unid.	
Voltaje	20V	Par	60 Nm
Velocidades	0-450/0-1900 RPM	Amperios	2Ah/4Ah/5Ah
Portabrocas	13 mm	Función percutor	0-22500 gpm

COD.710: COD 638 COMPLETO + 1 BATERÍA 5 Ah PVP: 288,56 €

TALADRO ATORNILLADOR IMPACTO LI-ION COD 0639

CIRLI2002

PVP: 222,82 €



- Motor sin escobillas
- Anclaje hexagonal de 1/4
- Linterna led integrada
- Reversible
- Incluye cargador y 2 baterías de 2 Ah
- Bolsa de tela

EAN	6925582129311	5 unid.
Voltaje	20V	
Velocidades	0-1300/0-2100 RPM	
Par	170 Nm	
Amperios	2Ah/4Ah/5Ah	
Impact	0-2000 / 0-3300 GPM	

COD.711: COD 639 COMPLETO + 1 BATERÍA 5 Ah PVP: 297,10 €

LLAVE DE IMPACTO LI-ION COD 0526

CIWLI2001

PVP: 199,51 €



- Motor sin escobillas
- Linterna led integrada
- Vasos 17-19 y 21
- Reversible
- Incluye cargador y 2 baterías 2Ah
- Bolsa de tela

EAN	6925582129328	5 unid.
Voltaje	20V	
Velocidades	0-1300/0-2100 RPM	
Medida cuadro	1/2	
Par	300 Nm	
Impacto	0-2000/0-3300 GPM	
Amperios	2Ah/4Ah/5Ah	

COD.529: COD 526 COMPLETO + 1 BATERÍA 5 Ah PVP: 273,79 €

MARTILLO COMBINADO LI-ION

COD 0358

CRHL1601

PVP: 94,98 €



- Reversible
- Brocas 6-8-10 SDS PLUS
- Linterna led integrada
- No incluye cargador ni batería
- Caja cartón INGCO

EAN	6925582129991	4 unid.
Voltaje	20V	
Velocidades	0-900 RPM	
Energía de Impacto	1,5 JULIOS	
Portabrocas	SDS PLUS	
Función percutor	5100 GPM	
Amperios	2Ah/4Ah/5Ah	

MARTILLO COMBINADO LI-ION

COD 0531

CRHL20228

PVP: 183,77 €



- Motor sin escobillas
- Reversible
- Función demoledor
- Brocas 6-8-10 y puntero SDS PLUS
- Linterna led integrada
- No incluye cargador ni batería
- Caja cartón INGCO

EAN	6941640169723	4 unid.
Voltaje	20V	
Velocidades	0-1350 RPM	
Energía de Impacto	1,5 JULIOS	
Portabrocas	SDS PLUS	
Función percutor	0-4700 GPM	
Amperios	2Ah/4Ah/5Ah	

TALADRO PERCUTOR BRUSHLESS LI-ION 20V+ PACK AMOLADORA

COD 0740

CKLI6015

PVP: 364,69 €



- Motor sin escobillas
- 23+1+1 Posiciones par
- Linterna led integrada
- Reversible
- Incluye cargador y 2 baterías de 4 Ah
- Bolsa de tela

EAN	6941640182074	6 unid.
Voltaje	20V	
Velocidad	3000-8500 RPM	
Amperios	2Ah/4Ah/5Ah	
Diámetro	115 mm	



MINI AMOLADORA LI-ION 115MM
COD 0417
CAGLI201158
PVP: 80,63 €

- Motor sin escobillas.
- No incluye cargador ni batería
- Caja cartón INGCO

EAN	6941640169556		6 unid.
Voltaje	20V		
Velocidad	3000-8500 RPM		
Amperios	2Ah/4Ah/5Ah		
Diámetro	115 mm		

MINI AMOLADORA LI-ION 125MM
COD 0741
CAGLI201258
PVP: 81,30 €

Battery and charger sold separately

- Motor sin escobillas.
- No incluye cargador ni batería
- Caja cartón INGCO

EAN	6941640174291		6 unid.
Voltaje	20V		
Velocidad	3000-8500 RPM		
Amperios	2Ah/4Ah/5Ah/7,5Ah		
Diámetro del disco	125 mm		

SIERRA CIRCULAR LI-ION
COD 0536
CSLI1651
PVP: 122,05 €

- No incluye cargador ni batería
- Inclinable 45°
- Control de profundidad
- Caja cartón INGCO

EAN	6925582145274		2 unid.
Voltaje	20V		
Velocidades	4600 RPM		
Capacidad de corte máximo	55 mm		
Diámetro de disco	165 mm		
Amperios	2Ah/4Ah/5Ah		

PACKS AMOLADORA LI-ION 115MM



DESCRIPCIÓN	COD	PVP
Amoladora LI-ION + cargador 20v + 2 bat 2 Ah	0419	167,91 €
Amoladora LI-ION + cargador 20v + 2 bat 4 Ah	0421	212,87 €
Amoladora LI-ION + cargador 20v + 2 bat 5 Ah	0717	249,71 €
Amoladora LI-ION + cargador 20v + 2 bat 7,5Ah	0734	329,75 €

PACKS AMOLADORA LI-ION 115MM

DESCRIPCIÓN	COD	PVP
Amoladora LI-ION + cargador 20v + 2 bat 2 Ah	0735	168,58 €
Amoladora LI-ION + cargador 20v + 2 bat 4 Ah	0736	213,54 €
Amoladora LI-ION + cargador 20v + 2 bat 5 Ah	0737	250,38 €
Amoladora LI-ION + cargador 20v + 2 bat 7,5Ah	0738	330,42 €

PACKS SIERRA CIRCULAR LI-ION

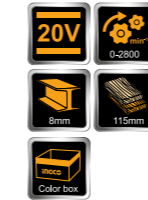
DESCRIPCIÓN	COD	PVP
Sierra circular LI-ION + cargador 20v + 2 bat 2 Ah	0538	209,33 €
Sierra circular LI-ION + cargador 20v + 2 bat 4 Ah	0540	254,29 €
Sierra circular LI-ION + cargador 20v + 2 bat 5 Ah	0719	291,13 €
Sierra circular LI-ION + cargador 20V + 2 bat 7,5Ah	0739	371,17 €

SIERRA SABLE LI-ION
COD 0357
CRSLI1151
PVP: 122,43 €

- Hoja metal y madera

EAN	6925582131338		4 unid.
Voltaje	20V		
Velocidades	0 - 3.200 RPM		
Capacidad de corte	8 mm - metal		
	115 mm - madera		
Amperios	2Ah/4Ah/5Ah		

SIERRA DE CALAR LI-ION
COD 0359
C-JSLI8501
PVP: 92,44 €

- No incluye cargador ni batería
- Blister hojas madera.
- Caja cartón INGCO

EAN	6925582130003		5 unid.
Voltaje	20V		
Velocidades	0 - 2.900 RPM		
Capacidad de corte	10 mm - metal		
	85 mm madera		
Amperios	2Ah/4Ah/5Ah		

LIJADORA ROTORBITAL LI-ION
COD 0517
CROSLI2001
PVP: 80,61€

- No incluye cargador ni batería
- Aspiración integrada
- Caja cartón INGCO
- Incluye 5 lijas

EAN	6925582134469		4 unid.
Voltaje	20V		
Velocidades	10.000 RPM		
Amperios	2Ah/4Ah/5Ah		
Diámetro	125 mm		

PACKS SIERRA SABLE LI-ION

DESCRIPCIÓN	COD	PVP
Sierra sable LI-ION + cargador + 2 bat 2 Ah	0427	209,71 €
Sierra sable LI-ION + cargador + 2 bat 4 Ah	0429	254,67 €
Sierra sable LI-ION + cargador + 2 bat 5 Ah	0721	291,51 €
Sierra sable LI-ION + cargador + 2 bat 7,5 Ah	0742	371,55 €

PACKS SIERRA DE CALAR LI-ION

DESCRIPCIÓN	COD	PVP
Sierra de calar LI-ION + cargador +2 bat 2Ah	0431	179,72 €
Sierra de calar LI-ION + cargador +2 bat 4Ah	0433	224,68 €
Sierra de calar LI-ION + cargador +2 bat 5Ah	0723	261,52 €
Sierra de calar LI-ION + cargador +2 bat 7,5Ah	0743	341,56 €

PACKS LIJADORA ROTORBITAL LI-ION

DESCRIPCIÓN	COD	PVP
Lijadora rotorbital LI-ION + cargador 20v + 2 bat 2Ah	0519	167,89 €
Lijadora rotorbital LI-ION + cargador 20v + 2 bat 4Ah	0521	212,85 €
Lijadora rotorbital LI-ION + cargador 20v + 2 bat 5Ah	0725	249,69 €
Lijadora rotorbital LI-ION + cargador 20v + 2 bat 7,5Ah	0744	329,73 €

LIJADORA MOUSE LI-ION 20V

COD 0745

PACKS LIJADORA MOUSE LI-ION

CDSL2051

PVP: 52,06 € €



- No incluye cargador ni batería
- Aspiración integrada
- Caja cartón INGCO
- Incluye 5 lijas

EAN	6941640161734		4 unid.
Voltaje	20V		
Velocidades	10.000 RPM		
Amperios	2Ah/4Ah/5Ah		
Diámetro	125 mm		



DESCRIPCIÓN	COD	PVP
Lijadora Mouse LI-ION + cargador 20v + 2 bat 2Ah	0746	139,34 €
Lijadora Mouse LI-ION + cargador 20v + 2 bat 4Ah	0747	184,30 €
Lijadora Mouse LI-ION + cargador 20v + 2 bat 5Ah	0748	221,14 €
Lijadora Mouse LI-ION + cargador 20v + 2 bat 7,5Ah	0749	301,18 €

MULTIHERRAMIENTAS LI-ION

COD 0360

PACKS MULTIHERRAMIENTAS LI-ION

CMLI2001

PVP: 58,94 € €



- Accesorios incluidos.
- No incluye cargador ni batería
- Caja cartón INGCO

EAN	6925582135312		8 unid.
Voltaje	20V		
Velocidades	5.000 - 20.000 RPM		
Amperios	2Ah/4Ah/5Ah		



DESCRIPCIÓN	COD	PVP
Multiherramienta LI-ION + cargador 20v + 2 bat 2Ah	0435	146,22 €
Multiherramienta LI-ION + cargador 20v + 2 bat 4Ah	0437	191,18 €
Multiherramienta LI-ION + cargador 20v + 2 bat 5Ah	0727	228,02 €
Multiherramienta LI-ION + cargador 20v + 2 bat 7,5Ah	0750	308,06 €

PISTOLA PINTAR LI-ION

COD 0361

PACKS PISTOLA PINTAR LI-ION

CSGLI2001

PVP: 68,22 € €



- No incluye cargador ni batería
- Caja cartón INGCO

EAN	6925582128376		8 unid.
Voltaje	20V		
Viscosidad máxima	40 DIN-s		
Pulverización máxima	600 MI/min		
Depositor	800 MI		
Amperios	2Ah/4Ah/5Ah		



DESCRIPCIÓN	COD	PVP
Pistola pintar LI-ION + cargador 20v + 2 bat 2Ah	0542	155,50 €
Pistola pintar LI-ION + cargador 20v + 2 bat 4Ah	0544	200,46 €
Pistola pintar LI-ION + cargador 20v + 2 bat 5Ah	0731	237,30 €
Pistola pintar LI-ION + cargador 20v + 2 bat 7,5Ah	0761	317,34 €

CLAVADORA LI-ION 20V

COD 0751

PISTOLA COLA TERMOFUSIBLE LI-ION

COD 0752

CBNL2016

PVP: 254,96 € €

CGGLI2001

PVP: 24,86 € €



- Incluye cargador y 1 batería de 20 V 2,0 Ah
- Tipo de clavo: F15-F50
- Adecuado para: ANA18201, ANA18251, ANA18301, ANA18351, ANA18401, ANA18501
- Caja cartón INGCO*

EAN	6941640184078		6 unid.
Voltaje	20V		
Velocidad máx	2,5 clavos/seg		
Capacidad	100 clavos		
Presión	8 Bar máx.		



- Con 3 barras de pegamento de 150 mm.
- NO incluye batería ni cargador
- Envasado en doble blister

EAN	6925582130010		6 unid.
Voltaje	20V		
Capacidad de encendido	15-18 gr/min		
Diámetro barra cola	11,2 mm		
Tiempo calentamiento	60 sg		

COMPRESOR AIRE LI-ION

COD 0363

ASPIRADOR LI-ION

COD 00545

CACLI2001

PVP: 50,30 € €

CVLI2001

PVP: 74,34 € €



- No incluye cargador ni batería
- Caja cartón INGCO

EAN	6925582128086		4 unid.
Voltaje	20V		
Presión máxima	11 Bar		
Amperios	2Ah/4Ah/5Ah		



- No incluye cargador ni batería
- Accesorios incluidos
- Caja cartón INGCO

EAN	6925582139150		4 unid.
Voltaje	20V		
Presión de vacío	7 KPA		
Depósito	0,7 L		
Diámetro de disco	165 mm		
Amperios	2Ah/5 Ah		

LINTERNA LI-ION

COD 0362

FOCO LED LI-ION

COD 0364

CWLI2001

PVP: 36,50 € €

CWLI2025

PVP: 59,71 € €



- No incluye cargador ni batería
- Caja cartón INGCO

EAN	6925582129878		6 unid.
Voltaje	20 V		
Amperios	2Ah/4Ah/5Ah		
Potencia	3,2 W		
Lumens	225		



- No incluye cargador ni batería
- Caja cartón INGCO
- Autonomía a 750 Lumens: batería de 2 Ah. 5 Horas, batería 4 Ah. 10 Horas
- Autonomía a 1500 Lumens: batería de 2 Ah. 2.5 Horas, batería de 4 Ah 5 Horas

EAN	6941640158994		6 unid.
Voltaje	20 V		
Potencia	32 W		
Amperios	2Ah/4Ah/5Ah		
Lumens	750 - 1500		
Rotación	360°		

SIERRA LI-ION NANOBLADE

CGSLI2068

COD 0642

PVP: 165,87 € €



- Motor sin escobillas
- No incluye cargador ni batería
- Voltaje 20V
- Espada 6"
- Capacidad de corte 120mm
- Amperios 2 Ah / 4 Ah / 5 Ah

DESCRIPCIÓN	EAN	6941640156518	5 unid.	COD	PVP
Sierra Nanoblade + cargador 20V + 2 bat 2Ah	0707	253,15 €			
Sierra Nanoblade + cargador 20V + 2 bat 4Ah	0709	298,11 €			
Sierra Nanoblade + cargador 20V + 2 bat 5Ah	0729	334,95 €			
Sierra Nanoblade + cargador 20V + 2 bat 7,5Ah	0753	414,99 €			

MOTOSIERRA LI-ION

CGSLI20128

COD 0754

PVP: 239,38 € €



Battery and charger sold separately

- Motor sin escobillas
- La batería y el cargador se venden por separado
- Caja cartón INGCO

EAN	6941640163668	6 unid.
Voltaje	20V	
Longitud espada	30 cm	
Velocidad de la cadena	7,9 m/s	

TIJERA PODA LI-ION

CSSLI203083

COD 0755

PVP: 207,68 € €



- Motor sin escobillas
- Incluye 1 batería 2.0Ah y cargador.
- Maleta transporte BMC

EAN	6941640164889	6 unid.
Voltaje	20V	
Diámetro de corte	20 mm/30 mm	

ESPADA MOTOSIERRA BATERÍA

AGSB51201

COD 0762

PVP: 14,24 € €



- Espada para motosierra 12" 300mm
- Adecuado para motosierras: CGSLI2001
- CGSLI20128 CGSLI201286
- UCGSLI201286

EAN	6941640156488	20 unid.
-----	---------------	----------

CADENA MOTOSIERRA BATERÍA

AGSC51201

COD 0763

PVP: 13,66 € €



- Cadena para motosierra 12" 300mm
- Adecuado para motosierras: CGSLI2001
- CGSLI20128 CGSLI201286
- UCGSLI201286

EAN	6941640169273	20 unid.
-----	---------------	----------

CORTABORDES LI-ION

CGTLI20018

COD 0756

PVP: 78,30 € €



- La batería y el cargador se venden por separado
- Caja cartón INGCO

EAN	6941640143006	6 unid.
Voltaje	20 V	
Velocidad sin carga	8200 rpm	
Diámetro corte	300 mm	
Diámetro hilo	1,6	
Capacidad hilo	5 mts	

CORTASETOS 200MM LI-ION

CSTLI2001

COD 0758

PVP: 57,06 € €



- Cuchilla cortada con láser
- Material de la hoja:SK5
- La batería y el cargador se venden por separado
- Caja cartón INGCO

EAN	6941640146199	6 unid.
Voltaje	20 V	
Velocidad sin carga	1200 rpm	
Longitud de corte	200 mm	
Distancia entre dientes	8 mm	
Ancho cuchilla césped	100 mm	

SOPLADOR LI-ION

CABLI20428

COD 0760

PVP: 119,20 € €



- Motor sin escobillas
- La batería y el cargador se venden por separado.
- Caja cartón INGCO

EAN	6941640169051	6 unid.
Voltaje	20 V	
Velocidad motor	18500 rpm	
Volúmen aire	8,5 m³/min	
Velocidad aire	144 km/h	

DESBROZADORA LI-ION

CSTLI20018

COD 0757

PVP: 276,42 € €



- Motor sin escobillas
- Dos funciones: corte de césped y corte de arbustos.
- Con 1 cabezal de corte.
- Con 1 hoja 3T.
- La batería y el cargador se venden por separado
- Caja cartón INGCO

EAN	6941640148124	6 unid.
Voltaje	40 V (20V+20V)	
Velocidad sin carga	0-5000 rpm / 0-6500 rpm	
Diámetro corte	255 mm	
Diámetro hilo	2,0	
Capacidad hilo	5 mts	

CORTASETOS 460MM LI-ION

CHTLI20018

COD 0759

PVP: 101,24 € €



- Cuchilla cortada con láser
- La batería y el cargador se venden por separado
- Caja cartón INGCO

EAN	6941640130211	6 unid.
Voltaje	20 V	
Velocidad sin carga	2800 rpm	
Longitud de corte	460 mm	
Diámetro máximo corte	18 mm	

BATERÍA 20 V LITIO 2 AH

FBLI2001



- Indicador carga led

EAN	6925582128123	20 unid.
Voltaje	20V	
Amperios	2 Ah	

BATERÍA 20 V LITIO 4 AH

FBLI2002



EAN	6925582131505	12 unid.
Voltaje	20V	
Amperios	4 Ah	

BATERÍA 20V LITIO 5 AH

FBLI2003



- indicador carga led

EAN	6941640144478	12 unid.
Voltaje	20V	
Amperios	5Ah	

BATERÍA 20V LITIO 7,5Ah

FBLI2075



- indicador carga led

EAN	6941640157065	12 unid.
Voltaje	20V	
Amperios	7,5 Ah	

COD 0367

PVP: 37,08 € €

BATERÍA 12 V LITIO

FBLI2152E



- Voltaje: 12 V
- Amperios: 1,5 Ah

EAN	6941640121196	20 unid.
-----	---------------	----------

CARGADOR BATERÍAS

FCLI12071E



- Voltaje: 12 V
- Carga completa: 2h

EAN	6941640108487	20 unid.
-----	---------------	----------

CARGADOR USB 20V

CUCLI2001



- No incluye cargador ni batería
- Caja cartón INGCO
- Potencia de salida: 5v / 1A - 5v / 2A
- Batería 4Ah

EAN	6925582140941	20 unid.
-----	---------------	----------

CARGADOR BATERÍA 20 V LITIO

FCLI2001E



- Voltaje: 20V
- Carga completa: 2 h

EAN	6925582131567	20 unid.
Amperios	2Ah/4Ah/5Ah	

CARGADOR RAPIDO BATERÍA 20V LITIO

FCLI2003



- Voltaje 20V
- Carga completa: 0,5 h / 1 h

EAN	6973138720109	20 unid.
Amperios	2Ah/4Ah/5Ah	

COD 0365

PVP: 22,35 € €

TALADRO 680W

ID6808E



- Electrónico y reversible
- Caja cartón INGCO

EAN	6941640166852	5 unid.
Voltaje	220 - 240 V / 50 - 60 Hz	
Potencia	680 W	
Velocidades	0-3000 RPM	
Portabrocas	13 mm	
Función percutor	48000 gpm	

TALADRO PERCUTOR

ID8508-2



- Electrónico y reversible
- Caja cartón INGCO
- Portabrocas automático

EAN	6925582128130	5 unid.
Voltaje	220 - 240 V / 50 - 60 Hz	
Potencia	850 W	
Velocidades	0 - 2.700 RPM	
Portabrocas	13 m/m	
Función percutor	43.200 gpm	

COD 0635

PVP: 48,17 € €

TALADRO PERCUTOR

ID7508



- Electrónico y reversible
- Caja cartón INGCO

EAN	6925582102598	5 unid.
Voltaje	220 - 240 V / 50 - 60 Hz	
Potencia	750 W	
Velocidades	0 - 3.000 RPM	
Portabrocas	13 m/m	
Función percutor	48.000 gpm	

TALADRO PERCUTOR

ID11008



- Electrónico y reversible
- Caja cartón INGCO

EAN	6928073604458	5 unid.
Voltaje	220 - 240 V / 50 - 60 Hz	
Potencia	1.100 W	
Velocidades	0 - 2.800 RPM	
Portabrocas	13 m/m	
Función percutor	44.800 gpm	

COD 0005

PVP: 57,47 € €

COD 0007

PVP: 81,84 € €

MARTILLO LIGERO

RGH9028



- Peso 3 kg
- Acc: 3 brocas, puntero y cincel
- Capacidad 26mm
- Maleta transporte BMC
- SDS plus

EAN	6925582142273		2 unid.
Voltaje	220 - 240 V / 50 - 60 Hz		
Potencia	800 W		
Velocidad	0-1200 RPM		
Energía impacto	2,5J		
Función percutor	5300gpm		

MARTILLO COMBINADO

RH16008



- Peso: 7,5 kg
- Acc: Brocas 18-22, cincel, puntero y grasa
- SDS MAX
- Maleta transporte BMC

EAN	6925582119572		2 unid.
Voltaje	220 - 240 V / 50 - 60 Hz		
Potencia	1.600 W		
Velocidades	550 RPM		
Capacidad hormigón	38 MM		
Energía impacto	8 J		
Función percutor	3850 gpm		

COD 0008

PVP: 115,57 € €

MARTILLO COMBINADO

RH150028



- Peso: 5 kg
- Acc: Brocas 8-10-12, cincel, puntero y grasa
- SDS PLUS
- Maleta transporte BMC

EAN	6925582126495		2 unid.
Voltaje	220 - 240 V / 50 - 60 Hz		
Potencia	1.500 W		
Velocidades	850 RPM		
Capacidad	32 MM		
Energía impacto	5,5 J		
Función percutor	0 - 4.400 gpm		

COD 0602

PVP: 234,06 € €

MARTILLO COMBINADO

RH17001



- Peso: 16 kg
- Acc: Brocas 16-18-22, cincel, puntero y grasa
- Embrague de seguridad
- Maleta transporte BMC

EAN	6928073600870		1 unid.
Voltaje	220 - 240 V / 50 - 60 Hz		
Potencia	1.700 W		
Velocidades	200 - 340 RPM		
Capacidad hormigón	65 MM SDS MÁX		
Energía impacto	27 J		
Función percutor	1.150 -1.850 gpm		

COD 0009

PVP: 148,19€ €

MARTILLO DEMOLEDOR

PDB130018



- Peso: 6 kg
- Acc: puntero, cincel y grasa.
- Anclaje hexagonal 17 mm
- Maleta BMC

EAN	6941640158468		2 unid.
Voltaje	220 - 240 V / 50 - 60 Hz		
Potencia	1.300 W		
Energía impacto	20 J		
Función percutor	3.800 gpm		

MARTILLO DEMOLEDOR

PDB17008



- Peso: 13 kg
- Cable: 4 m
- Anclaje hexagonal 30 mm
- Acc: puntero, cincel
- Lubricación con aceite 15W40
- Maleta transporte BMC con ruedas

EAN	6925582106930		1 unid.
Voltaje	220 - 240 V / 50 - 60 Hz		
Potencia	1.700 W		
Energía impacto	45 J		
Función percutor	1.400 gpm		

COD 0416

PVP: 190,20€ €

MARTILLO DEMOLEDOR

PDB15006

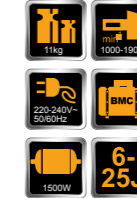

- Peso: 11 kg
- Acc: puntero, cincel y grasa
- SDS MAX
- Maleta transporte BMC

EAN	6925582112122		1 unid.
Voltaje	220 - 240 V / 50 - 60 Hz		
Potencia	1.500 W		
Energía impacto	6 - 25 J		
Función percutor	1.000 - 1.900 gpm		

MARTILLO DEMOLEDOR

PDB22001



- Peso: 30 kg
- Cable: 4 m
- Anclaje hexagonal 28 mm
- Acc: Puntero, cincel, estuche llaves allen y grasa

EAN	6925582108309		1 unid.
Voltaje	220 - 240 / V 50 - 60 Hz		
Potencia	2.200 W		
Energía impacto	75 J		
Función percutor	950 gpm		

COD 0277

PVP: 392,75 € €

SIERRA DE CALAR

COD 0018

JS57028

PVP: 57,34 € €



- Inclinación de la base: 45°
- Avance pendular
- Acc: 3 sierras.
- Caja de cartón INGCO

EAN	6925582138665		5 unid.
Voltaje	220 - 240 V / 50 - 60 Hz		
Potencia	570 W		
Velocidades	800 - 3.000 RPM		
Capacidad corte	8 mm - metal		
	115 mm - madera		

SIERRA DE CALAR

COD 0369

JS80028-1

PVP: 92,35 € €



- Inclinación de la base: 45°
- Avance pendular
- Acc: Blister 5 hojas madera metal
- Caja de cartón INGCO

EAN	6925582136784		5 unid.
Voltaje	220 - 240 V / 50 - 60 Hz		
Potencia	800 W		
Velocidades	500 - 3.000 RPM		
Capacidad corte	10 mm - metal		
	110 mm - madera		

SIERRA DE SABLE

COD 0016

RS8008

PVP: 95,23 € €



- Acc: Hoja metal y madera
- Caja cartón INGCO

EAN	6925582129298		4 unid.
Voltaje	220 - 240 V / 50 - 60 Hz		
Potencia	750 W		
Velocidades	2800 RPM		
Capacidad corte	5 mm - metal		
	115 mm - madera		

SIERRA DE SABLE 1

COD 0766

RS12001

PVP: 152,80 € €



- Acc: Hoja metal y madera
- Caja cartón INGCO

EAN	6941640180025		4 unid.
Voltaje	220 - 240 V / 50 - 60 Hz		
Potencia	1200 W		
Velocidades	2800 RPM		
Capacidad corte	5 mm - metal		
	115 mm - madera		

ENSAMBLADORA

COD 0015

BJ9508

PVP: 126,39 € €



- Bolsa aspiración
- ACC: 15 galletas N°20
- Caja de cartón INGCO

EAN	6925582119862		4 unid.
Voltaje	220 - 240 V / 50 - 60 Hz		
Potencia	950 W		
Velocidades	11.000 RPM		
Diámetro disco	100 mm		

MULTI HERRAMIENTAS ELECTRICAS

COD 0643

MF3008

PVP: 64,52 € €



- 8 Accesorios incluidos.
- Caja cartón INGCO

EAN	6925582127027		8 unid.
Voltaje	220 - 240 V 50 - 60 HZ		
Potencia	300 W		
Velocidades	10000-20000 RPM		

SIERRA TRONZADORA TELESCÓPICA CON MESA 1800W

COD 0767

MT2S18002

PVP: 799,72 €



1800W

Ø305mm



- Base de aluminio
- Capacidad máxima mesa: 58 mm
- Capacidad corte ungleadora:
0°/0°: 90 mm x 305 mm - 0°/45°: 60 mm x 215 mm - 45°/0°: 90 mm x 215 mm - 45°/45°: 60 mm x 215 mm
- Doble guía desplazamiento

EAN	6925582149166		1 unid.
Voltaje	220 - 240 V / 50 - 60 Hz		
Potencia	1.800 W		
Velocidad sin carga	3.600 RPM		
Diámetro del disco	305 x 30 mm		
Medida mesa	310 x 480 mm		

TRONZADORA MADERA

BMS14002



- Aspiración incluida
- Confeccionada en aluminio
- Base giratoria
- Cabezal inclinable

EAN	6928073603321	1 unid.
Voltaje	220 - 240 V / 50 - 60 Hz	
Potencia	1.400 W	
Velocidades	5.000 RPM	
Capacidad de corte máximo	120 x 55 mm	
Diámetro del disco	210 mm	
Diámetro del eje	25,4 mm	

LIJADORA MANO

PS2408



- Con 5 papeles de lija (AKFS140102)
- Con 1 juego de escobillas de carbón adicionales
- Caja cartón INGCO

EAN	6925582124057	6 unid.
Voltaje	220 - 240 V / 50 - 60 Hz	
Potencia nominal	240 W	
Velocidades sin carga	11.000 RPM	

LIJADORA MOUSE

MS6505



- Con 3 hojas de lija para dedos.
- Con 6 papeles de lija
- Con 1 bolsa de polvo.
- Con 1 almohadilla para los dedos.
- Caja cartón INGCO

EAN	6941640160331	6 unid.
Voltaje	220 - 240 V / 50 - 60 Hz	
Potencia nominal	65 W	
Velocidades sin carga	11.000 RPM	

SIERRA CIRCULAR

CS18568



- Inclinable 45°
- Control profundidad
- Caja cartón INGCO

EAN	6925582126112	2 unid.
Voltaje	220 - 240 V / 50 - 60 Hz	
Potencia	1.400 W	
Velocidades	4800 RPM	
Capacidad de corte máximo	65 mm	
Diámetro del disco	185 mm	
Diámetro del eje	20 mm	

CEPILLO ELÉCTRICO

PL10508



- Cuchilla reversible 82 x 3 mm

EAN	6925582123333	4 unid.
Voltaje	220 - 240 V 50 - 60 Hz	
Potencia	1.050 W	

LIJADORA ORBITAL

FS3208

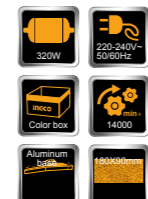

- Base de aluminio
- Incluye 5 lijas
- Caja cartón INGCO
- (P80 3 pcs + P120 2pcs)

EAN	6925582117660	6 unid.
Voltaje	220 - 240 V / 50 - 60 Hz	
Potencia	320 W	
Velocidades	14.000 RPM	
Medida base	185 x 9 mm	

LIJADORA ORBITAL

FS35028



- Base de aluminio
- Caja de cartón INGCO
- Incluye 5 lijas (P120)

EAN	6925582125665	6 unid.
Potencia	350 W	
Velocidades	11.000 RPM	
Medida base	210 x 110 mm	

ASPIRADOR INDUSTRIAL

VC12302



- 1 Pcs manguera flexible
- 1Pcs cepillo
- 1Pcs tubo de plástico
- 1Pcs filtro hefa
- Limpieza en seco y mojado
- Adaptador para herramientas eléctricas
- Embalado en caja de cartón
- Material tanque: acero inoxidable
- Depósito: 30 l
- Función soplador

EAN	6925582133837	1 unid.
Voltaje	220 - 240 V / 50 - 60 Hz	
Potencia	1.200 W	
Flujo de aire	1.9 cbm/min	
Presión de vacío	16 -18 KPA	
Depósito	30 l acero inox.	

ASPIRADOR-SOPLADOR

AB6008



- Bolsa aspiración incluida
- Caja cartón INGCO

EAN	6928073607442	4 unid.
Voltaje	220 - 240 V / 50 - 60 Hz	
Potencia	600 W	
Velocidades	0 - 16.000 RPM	
Aire desplazado	0 - 3,5 m³/min	
Longitud total	43 cm	

FILTRO ASPIRADOR VC12302

VCAIHP02



EAN	6925582123227	1 unid.
-----	---------------	---------

LIJADORA DE BANDA

PBS12001



- Cuerpo aluminio
- Bolsa aspiración incluida
- Caja de cartón INGCO
- Incluye 1 lija (P80)

EAN	6928073600085	2 unid.
Voltaje	220 - 240 V / 50 - 60 Hz	
Potencia	1.200 W	
Velocidades	500 m/min	
Medida banda lija	610 x 100 mm	

LIJADORA ROTORBITAL

RS4508



- Caja cartón INGCO
- Base de aluminio
- Incluye 5 lijas (P80)

EAN	6925582136937	6 unid.
Voltaje	220 - 240 V / 50 - 60 Hz	
Potencia	450 W	
Velocidades	4.000 - 13.000 RPM	
Diámetro	150 mm	

MEZCLADORA DE PINTURAS INDUSTRIAL

MX214008



- Incluye una paleta mezcladora
- Cuerpo y caja de cambios de aluminio
- Caja cartón INGCO

EAN	6925582135107	2 unid.
Voltaje	220 - 240 V / 50 - 60 Hz	
Potencia	1.400 W	
Medida de la mecha	M14	

FILTRO ASPIRADOR VC24751

VCAIHP03



EAN	6925582126471	1 unid.
-----	---------------	---------

LIJADORA DE BANDA

PBS12001

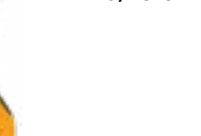

- Cuerpo aluminio
- Bolsa aspiración incluida
- Caja de cartón INGCO
- Incluye 1 lija (P80)

EAN	6928073600085	2 unid.
-----	---------------	---------

LIJADORA ROTORBITAL

RS4508



- Caja cartón INGCO
- Base de aluminio
- Incluye 5 lijas (P80)

EAN	6925582136937	6 unid.
-----	---------------	---------

MEZCLADORA DE PINTURAS INDUSTRIAL

MX214008



- Incluye una paleta mezcladora
- Cuerpo y caja de cambios de aluminio
- Caja cartón INGCO

EAN	6925582135107	2 unid.
-----	---------------	---------

FILTRO ASPIRADOR VC24751

VCAIHP03



EAN	6925582126471	1 unid.
-----	---------------	---------

MINI AMOLADORA

AG75018E



- Tuerca M-14
- Caja de cartón INGCO

EAN	6925582143492		10 unid.
Voltaje	220 - 240 V / 50 - 60 Hz		
Potencia	750 W		
Velocidades	12.000 RPM		
Diámetro	115 mm		

MINI AMOLADORA

AG8528E

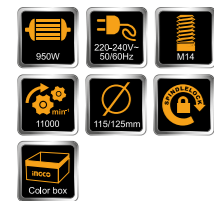

- Tuerca M-14
- Caja cartón INGCO

EAN	6941640137258		6 unid.
Voltaje	220 - 240 V / 50 - 60 Hz		
Potencia	950W		
Velocidades	12.000 RPM		
Diámetro	125 mm		

COD 0441

PVP: 54,22 € €

MINI AMOLADORA

AG8508E



- Tuerca M-14
- Caja de cartón INGCO

EAN	6925582118438		6 unid.
Voltaje	220 - 240 V / 50 - 60 Hz		
Potencia	950 W		
Velocidades	11.000 RPM		
Diámetro	115 mm		

COD 0033

PVP: 73,29 € €

AMOLADORA ANGULAR

AG24008E



- Tuerca M-14
- Caja de cartón INGCO

EAN	6925582132267		2 unid.
Voltaje	220 - 240 V / 50 - 60 Hz		
Potencia	2.400 W		
Velocidades	6.300 RPM		
Diámetro	230 mm		

COD 0035

PVP: 148,28 € €

PULIDORA

AP14008



- Acc:Funda de lana
- Caja de cartón INGCO

EAN	6925582121148		4 unid.
Voltaje	220 - 240 V / 50 - 60 Hz		
Potencia	1.400 W		
Velocidades	900 - 3.800 RPM		
Diámetro	180 mm		

AMOLADORA ANGULAR

AG10108



- Tuerca M-14
- Caja de cartón INGCO

EAN	6925582121537		6 unid.
Voltaje	220 - 240 V / 50 - 60 Hz		
Potencia	1.010 W		
Velocidades	12.000 RPM		
Diámetro	125 mm		

COD 0644

PVP: 65,85 € €

ROZADORA DE MUROS

WLC15008



- Tuerca M-14
- Acc: 4 discos y cincel
- Caja de cartón INGCO

EAN	6925582132083		2 unid.
Voltaje	220 - 240 V / 50 - 60 Hz		
Potencia	1.500 W		
Velocidad	9.000 rpm		
Diámetro	125 mm		
Corte profundidad	3 - 29 mm		
Corte ancho	8 - 30 mm		

COD 0370

PVP: 114,91 € €

COD 0442

PVP: 215,33 € €

LIJADORA DE MUROS
DWS1050

COD 0770
PVP: 310,90 € €

1050W



- Diámetro de la manguera de polvo: 38 mm
- Luz de trabajo integrada
- 6 papeles de lija.
- Adaptadores de conexión y tubo flexible de 4m.
- Barra de extensión 1 pcs.
- 1 bolsa de polvo.
- 1 juego de escobillas de carbón adicionales.

EAN	6925582127515		1 unid.
Voltaje	220 - 240 V / 50 - 60 Hz		
Potencia	1.050 W		
Velocidad sin carga	600-2300 RPM		
Diámetro del disco	225 mm		
Diámetro de tubo	32 mm		

MOTOSIERRA GASOLINA
GCS5261011

COD 0645
PVP: 186,34 €



- Freno de seguridad
- Caja de cartón INGCO

EAN	6941640135353		2 unid.
Motor	1 HP-2 tiempos		
Cubicaje	25,4 Cc		
Deposito combustible	230 ml		
Deposito aceite	160 ml		
Longitud espada	25 cm		
Peso	3,5 kg		

MOTOSIERRA GASOLINA
GCS5451811

COD 0647
PVP: 203,11 €



- Freno de seguridad
- Caja de cartón INGCO

EAN	6941640132949		2 unid.
Motor	2,41 HP-2 tiempos		
Cubicaje	46 Cc		
Deposito combustible	550 ml		
Deposito aceite	260 ml		
Longitud espada	45 cm		
Peso	6 kg		

MOTOSIERRA GASOLINA
GCS5411611

COD 0646
PVP: 197,45 €



- Freno de seguridad
- Caja de cartón INGCO

EAN	6941640133809		2 unid.
Motor	2 HP-2 tiempos		
Cubicaje	41 Cc		
Deposito combustible	260 ml		
Deposito aceite	210 ml		
Longitud espada	40 cm		
Peso	5 kg		

DESBROZADORA GASOLINA
GBC5434421

COD 0648
PVP: 248,34 €



- 2 funciones, cortador y recortador
- Caja de cartón INGCO

EAN	6941640119469		6 unid.
Cubicaje	42 cc		
Motor	2 hp-2 tiempos		
Velocidad máxima	9000 RPM		
Corte máximo	420 mm		
Carrete	2,4 mm x 4mm		
Diámetro de hoja	255 mm (3 dientes)		
Depósito combustible	1200 ml.		
Corte máximo	420 mm		

SOLDADORA INVERTER 120A

COD 0628

ING-MMA120E

PVP: 138,37 €



- Anti stick
- Control de temperatura
- Caja de cartón INGCO

EAN	6941640168207		1 unid.
Voltaje	220 - 240 V / 50 - 60 Hz		
Intensidad	0-120 Ah		
Capacidad	1,6 - 3,2		
Ciclo	120 Ah 20%		
Protección	IP21S		

SOLDADORA INVERTER 160A

COD 0629

ING-MMA160E

PVP: 179,36 €



- Anti stick
- Control de temperatura
- Caja de cartón INGCO

EAN	6941640150295		1 unid.
Voltaje	220 - 240 V / 50 - 60 Hz		
Intensidad	0-160 Ah		
Capacidad	1,6 - 4		
Ciclo	160 Ah 20%		
Protección	IP21S		

PANTALLA SOLDAR ELECTRÓNICA

COD 0064

AHM008

PVP: 56,22 €



- 92 x 42 mm
- Oscuridad variable de 9 - 13
- Caja cartón INGCO

EAN	6925582121605		6 unid.
-----	---------------	--	---------

PANTALLA SOLDAR ELECTRÓNICA

COD 0649

AHM001

PVP: 77,76 €



- 100 x 67 mm
- Oscuridad variable de 9 - 13
- Indicador de batería

EAN	6925582149340		6 unid.
-----	---------------	--	---------

PISTOLA AIRE CALIENTE

COD 0025

HG200038

PVP: 35,77 €



- 5 Acc. incluidos
- Caja de cartón INGCO

EAN	6925582148503		10 unid.
Voltaje	220 - 240 V / 50 - 60 Hz		
Potencia	2.000 W		
Velocidad	300 - 500 l/min		
Temperatura	350 - 550°		

PISTOLA COLA CALIENTE

COD 0651

GG6008

PVP: 9,85 €



- Diámetro 11,2
- 2 Recambios incluidos
- 13-18 gr/min

EAN	6941640163585		12 unid.
Voltaje	220 - 240 V / 50 - 60 Hz		
Potencia	100 W		

PISTOLA AIRE CALIENTE

COD 0650

HG200028

PVP: 42,25 €



- 5 Acc. incluidos
- Regulable en velocidad y temperatura.
- Caja de cartón INGCO

EAN	6925582131154		8 unid.
Voltaje	220 - 240 V / 50 - 60 Hz		
Potencia	2.000 W		
Velocidad	200 l/min - 300 l/min - 500 l/min		
Temperatura	50 - 380 - 570 °C		

PISTOLA COLA CALIENTE

COD 0026

GG308

PVP: 23,23 €



- Diámetro recambio 11,2 mm
- 8 Recambios incluidos.
- 20 - 30 gr/min

EAN	6925582138894		4 unid.
Voltaje	220 - 240 V / 50 - 60 Hz		
Potencia	220 W		

PISTOLA PINTAR **COD 0027**

SPG3508 **PVP: 47,30 €**



• Caja de cartón INGCO

EAN	6925582125719		4 unid.
Voltaje	220 - 240 V / 50 - 60 Hz		
Potencia	450 W		
Depósito	800 ml		
Diámetro boquilla	2,5 mm		
Pulverización	380 ml/min		
Densidad máx	50 DIN-s		

TURBINA PINTAR **COD 0652**

SPG5008-2 **PVP: 71,50 €**

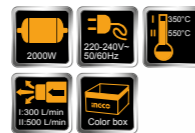

• Caja de cartón INGCO

EAN	6925582126235		4 unid.
Voltaje	220 - 240 V / 50 - 60 Hz		
Potencia	550 W		
Deposito	800 ml		
Diámetro boquilla	2,5 mm		
Pulverización	850 l/min		
Densidad	50 DIN-s		

SOLDADOR ESTAÑO **COD 0653**

SI00108 **PVP: 15,72 €**



EAN	6925582124712		50 unid.
Voltaje	220 - 240 V / 50 - 60 Hz		
Potencia	100 W		

MINI DRILL **COD 0344**

MG13328E **PVP: 44,25 €**



- Control de velocidad variable
- Con 1 eje flexible.
- Con 109 piezas de accesorios
- Con 1 juego de escobillas de carbón adicionales
- Maleta transporte BMC

EAN	6941640195388		5 unid.
Voltaje	220 - 240 V / 50 - 60 Hz		
Potencia	130 W		
Velocidad	10.000 - 35.000 RPM		
Tamaño de pinza	3,2 mm/2,3 mm		

MOTOBOMBAS

CATÁLOGO 2023

MOTOBOMBA GASOLINA

GWP152

COD 0772

PVP: 231,56 €



- Depósito combustible: 1.2 L

EAN	6941640124999		1 unid.
Diámetro de succión y descarga:	40 mm, 1,5"		
Flujo máx.:	167L/min		
Aspiración máx.:	7 m		
Impulsión máx.:	18 m		
Motor de gasolina de:	2.5HP		
Cubicaje:	105cc		

MOTOBOMBA GASOLINA

GWP302

COD 0043

PVP: 380,29 €



- Depósito combustible: 3.6 L

EAN	6925582100402		1 unid.
Motor	7,0 HP - 4 tiempos		
Cubicaje	208 Cc		
Impulsión	32 m		
Aspiración	8 m		
Caudal: 100 l/min	1.000 l/min - 60.000 l/hora		
Conexión	80 mm - 3"		

BOMBA SUMERGIBLE DE AGUAS NEGRAS

SPC4001

COD 0549

PVP: 83,02 €



- Caja de cartón INGCO

EAN	6925582143478		2 unid.
Voltaje	220 - 240 / V 50 Hz		
Potencia	400W (0,5HP)		
Máx. Cabeza	8 m		
Tasa máx. caudal:	117 l/min		
Máx. Profundidad	7 M		
Diámetro del tubo	1" con el cable 9 m		

MOTOBOMBA GASOLINA

GWP202

COD 0042

PVP: 346,81 €



- Depósito combustible: 3.6 L

EAN	6928073606872		1 unid.
Motor	7,0 HP - 4 tiempos		
Cubicaje	208 Cc		
Impulsión	28 m		
Aspiración	8 m		
Caudal: 100 l/min	550 l/min - 33.000 l/hora		
Conexión	50 mm - 2"		

MOTOBOMBA GASOLINA

GWP402

COD 0044

PVP: 705,66 €



- Depósito combustible: 6 L

EAN	6925582113280		1 unid.
Motor	9,0 HP - 4 tiempos		
Cubicaje	270 Cc		
Impulsión	30 m		
Aspiración	8 m		
Caudal: 100 l/min	1.500 l/min - 90.000 l/hora		
Conexión	100 mm - 4"		

BOMBA SUMERGIBLE DE AGUAS NEGRAS

SPD7508

COD 0209

PVP: 101,26 €



- Caja de cartón INGCO

EAN	6941640169266		2 unid.
Voltaje	220 - 240 / V 50 Hz		
Energía de entrada	750W (1.0 HP)		
Máx. Cabeza	8 m		
Tasa máx. caudal:	216 l/min		
Máx. Profundidad	7 M		
Diámetro del tubo	1" con el cable 9 m		

BOMBA SUMERGIBLE DE AGUAS NEGRAS

SPD10001

COD 0550

PVP: 145,96 €



- Caja de cartón INGCO

EAN	6925582143461		2 unid.
Voltaje	220 - 240 V/50 Hz		
Potencia	1000W (1,5HP)		
Máx. Cabeza	9 m		
Tasa máx. caudal:	333 l/min		
Máx. Profundidad	7 M		
Diámetro del tubo	2" con el cable 9 m		

LIMPIADORA ALTA PRESIÓN

HPWR14008

COD 0444

PVP: 146,10 €



- Acc:lanza y manguera 5 m
- Arranque y parada automático

EAN	6925582123845		1 unid.
Voltaje	220 - 240 V / 50 - 60 Hz		
Potencia	1.400 W		
Presión max	130 Bar		
Caudal	5,5 l/min		
Temperatura máxima	40°		

CEPILLO HIDROLIMPIADORA

AMHB2791

COD 0552

PVP: 19,70 €



- Medida 270x95 mm

EAN	6925582149548		1 unid.
-----	---------------	--	---------

CEPILLO REDONDO HIDROLIMPIADORA

AMPB251

COD 0553

PVP: 27,04 €



- Medida 455 mm

EAN	6925582149555		1 unid.
-----	---------------	--	---------

LIMPIADORA ALTA PRESIÓN

HPWR18008

COD 0443

PVP: 235,45 €



- Acc:lanza y manguera 5 m
- Arranque y parada automático
- Depósito detergente

EAN	6925582123852		1 unid.
Voltaje	220 - 240 V / 50 - 60 Hz		
Potencia	1.800 W		
Presión max	150 Bar		
Caudal	6 l/min		
Temperatura máxima	40°		

MANGUERA 5 M HIDROLIMPIADORA

AHPH5028

COD 0372

PVP: 18,08 €



EAN	6925582126273		1 unid.
-----	---------------	--	---------

LANZA HIDROLIMPIADORA

AMSG028

COD 0373

PVP: 27,77 €



EAN	6925582126280		1 unid.
-----	---------------	--	---------

CEPILLO LLANTAS VEHICULO HIDROLIMPIADORA

AMWB1781

COD 0554

PVP: 12,05 €



- Medida 390 mm

EAN	6925582149562		1 unid.
-----	---------------	--	---------

LANZA ARTICULADA HIDROLIMPIADORA

AMAN4501

COD 0555

PVP: 9,70 €



- Medida 590 mm

EAN	6925582149531		1 unid.
-----	---------------	--	---------

GENERADORES

CATÁLOGO 2023

GENERADOR GASOLINA 4 TIEMPOS

COD 0445

GE30005

PVP: 543,11 €



- Arranque manual
- AVR: control voltaje

EAN	6925582113020		1 unid.
Velocidades	3.000 RPM		
Voltaje	220-240 V / 50 Hz		
Potencia:	7 HP		
Cubicaje	210 Cc		
Depósito	15 l		
Máx. AC Output	2,8 KW		

GENERADOR GASOLINA 4 TIEMPOS

COD 0046

GE35006

PVP: 668,07 €



- Arranque manual
- AVR: control voltaje

EAN	6925582113518		1 unid.
Velocidades	3.000 RPM		
Voltaje	220-240 V / 50 Hz		
Potencia:	7 HP		
Cubicaje	208 Cc		
Depósito	15 l		
Máx. AC Output	3,5 KW		

GENERADOR GASOLINA 4 TIEMPOS

COD 0551

GE65006

PVP: 1443,64 €



- Arranque eléctrico y manual
- AVR: control voltaje

EAN	6925582113532		1 unid.
Velocidades	3.000 RPM	Cubicaje	420 Cc
Voltaje	220-240 V / 50 Hz	Depósito	25 l
Potencia:	15 HP	Máx. AC Output	6,5 KW

CONSUMIBLES

CATÁLOGO 2023

JUEGO BROCAS 5 PCS

COD 0281

AKDB3055

PVP: 3,37 €



- Obra general
- 4 x 75 mm / 5 x 85 mm / 6 x 100 mm / 8 x 120 mm / 10 x 120 mm
- 5 Pcs para hormigón
- Doble blíster

EAN 6928073713365 40 unid.

JUEGO BROCAS PRO 5 PCS

COD 0282

AKD3051

PVP: 6,89 €



- Obra general
- 4 x 75 mm / 5 x 85 mm / 6 x 100 mm / 8 x 120 mm / 10 x 120 mm
- 5 Pcs para hormigón
- Caja de plástico

EAN 6928073677728 24 unid.

JUEGO BROCAS 6 PCS

COD 0283

AKDB1065

PVP: 2,51 €



- HSS
- 2 x 49 mm / 3 x 61 mm / 4 x 75 mm / 5 x 86 mm / 6 x 93 mm / 8 x 117 mm
- 6 Pcs para metal
- Doble blíster

EAN 6925582102581 40 unid.

JUEGO BROCAS PRO 6 PCS

COD 0284

AKD1055

PVP: 3,84 €



- HSS
- 2 / 3 / 4 / 5 / 6 / 8 mm
- 6 Pcs para metal
- Caja de plástico

EAN 6928073680315 12 unid.

JUEGO BROCAS 12 PCS

COD 0285

AKDB1125

PVP: 5,01 €



- HSS
- 2 / 2.5 / 3 / 3.5 / 4 / 4.5 / 5 / 5.5 / 6 / 6.5 / 7 / 8 mm
- 12 Pcs para metal
- Doble blíster

EAN 6928073714515 20 unid.

JUEGO BROCAS PRO 19 PCS

COD 0286

AKDB1195

PVP: 12,64 €



- HSS
- 1 / 1.5 / 2 / 2.5 / 3 / 3.5 / 4 / 4.5 / 5 / 5.5 / 6 / 6.5 / 7 / 7.5 / 8 / 8.5 / 9 / 9.5 / 10 mm
- 19 Pcs para metal
- Caja de plástico

EAN 6928073713358 10 unid.

JUEGO BROCAS 5 PCS

AKDB5055



- Para madera
- 3 x 61 mm / 4x75 mm / 5 x 86 mm / 6 x 93 mm / 8 x 117 mm
- 5 Pcs para madera
- Doble blíster

EAN	6925582102574		40 unid.
-----	---------------	--	----------

COD 0287

PVP: 2,54 €

JUEGO BROCAS PRO 25 PCS

AKD1251



- 25 Pcs brocas HSS metal
- Brocas 135°
- Acero de alta velocidad y calidad m²
- Tamaño broca: 1-13 mm / 0,5 mm
- Caja de plástico

EAN	6925582100198		10 unid.
-----	---------------	--	----------

COD 0288

PVP: 93,58 €

PORTABROCAS



- Tamaño conexión: 3/8" 24 UNF

EAN	REF	COD		25 unid.	PVP
6928073660362	KC1001	0215		0,8 - 10 mm	4,55 €
6928073660379	KC1301	0216		1,5 m/m - 13mm	5,11 €

PORTABROCAS 13 MM CON ADAPTADOR

KC1301.1



- Tamaño conexión: 1/2"-20 UNF
- Adaptador incluido (1 pieza)

EAN	6928073666418		25 unid.
Portabrocas		1,5 m/m - 13mm	

PVP: 6,39 €

JUEGO BROCAS 16 PCS + PUNTAS

AKSDB9165



- 6 Pcs para metal 2 / 3 / 3.5 / 4 / 5 / 6 mm
- 4 Pcs para hormigón 4 / 5 / 6 / 8 mm
- 6 Pcs puntas de 25 mm
- SL4.5, SL5.5, PH1, PH2, PZ1, PZ2 • Doble blíster

EAN	6928073713372		20 unid.
-----	---------------	--	----------

COD 0289

PVP: 6,15 €

JUEGO BROCAS PRO 16 PCS

AKDL11601

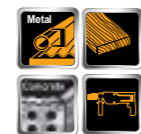

- 6 Pcs para metal 2 / 3 / 4 / 5 / 6 / 8 mm
- 5 Pcs para hormigón 4 / 5 / 6 / 8 / 10 mm
- 5 Pcs para madera 4 / 5 / 6 / 8 / 10 mm
- Caja de plástico

EAN	6925582147353		6 unid.
-----	---------------	--	---------

COD 0290

PVP: 12,78 €

PORTABROCAS AUTOMÁTICO

KCL1301



- 13 mm
- Tamaño conexión: 1/2" - 20 UNF

EAN	6928073668603		25 unid.
Portabrocas		1,5 m/m - 13mm	

COD 0269

PVP: 7,13 €

LLAVE DE MANDRIL

CK1301



- Clave para 13 mm
- Longitud llave de sujeción: 110 mm lleno por la tarjeta deslizante

EAN	6928073668610		25 unid.
-----	---------------	--	----------

COD 0218

PVP: 1,37 €

JUEGO DE BROCAS PRO SDS PLUS 5 PCS

AKD2052



- Brocas para hormigón
- Medida : 6 x 110 mm / 8 x 110 mm / 8 x 160 mm / 10 x 160 mm / 12 x 160mm
- Caja de plástico

EAN	6928073673263		5 unid.
-----	---------------	--	---------

COD 0291

PVP: 10,34 €

VARILLA MEZCLADORA

MP1160



- Diámetro: 160 mm
- Largo: 600 mm
- Para: M14 x 2
- Caja cartón

EAN	6928073667002		2 unid.
-----	---------------	--	---------

COD 0317

PVP: 21,96 €

VARILLA MEZCLADORA

MP1120



- Diámetro: 120 mm
- Largo: 600 mm
- Para: M14 x 2
- Caja cartón

EAN	6928073670132		2 unid.
-----	---------------	--	---------

COD 0446

PVP: 18,45 €

SET 250 PCS MINI DRILL

AKMG2501



EAN	6925582115062		5 unid.
-----	---------------	--	---------

COD 0345

PVP: 38,35 €

JUEGO ACCESORIOS MINI DRILL

AKMG4101



EAN	6941640162175		5 unid.
-----	---------------	--	---------

COD 0654

PVP: 40,52 €

PUNTERO SDS PLUS **COD 0292**

DBC0112501 **PVP: 2,52 €**



- 14 x 250 mm
- Adecuado para RGH9018, RH150028, RGH9028

EAN 6925582108262 50 unid.

CINCEL SDS PLUS **COD 0293**

DBC0122501 **PVP: 2,52 €**



- 14 x 250 x 20 mm
- Adecuado para RGH9018, RH150028, RGH9028

EAN 6925582108279 50 unid.

PUNTERO SDS MAX **COD 0374**

DBC0214001 **PVP: 6,68 €**



- 18 x 400 mm
- Adecuado para RH16008, RH17001, RH16008, PDB15006

EAN 6928073661840 25 unid.

CINCEL SDS MAX **COD 0375**

DBC0224001 **PVP: 6,86 €**



- 18 x 400 x 25 mm
- Adecuado para RH16008, RH17001, RH16008, PDB15006

EAN 6928073661871 25 unid.

PUNTERO HEXAGONAL 30MM **COD 0294**

DBC0314101 **PVP: 23,29 €**



- 30 x 410 mm
- Adecuado para PDB17008

EAN 6928073666319 10 unid.

CINCEL HEXAGONAL 30MM **COD 0295**

DBC0324102 **PVP: 23,29 €**



- 30 x 410 x 40 mm
- Adecuado para PDB17008

EAN 6928073666326 10 unid.

CINCEL PALA ANCHA SDS PLUS **COD 0447**

DBC0122502 **PVP: 3,73 €**



- 14 x 250 x 40 mm
- Adecuado para RGH9018, RH150028, RGH9028

EAN 6928073667200 50 unid.

CINCEL PALA ANCHA SDS MAX **COD 0448**

DBC0224002 **PVP: 7,88 €**



- 18 x 400 x 50 mm
- Adecuado para RH16008, RH17001, RH16008 Y PDB15006.

EAN 6928073666241 25 unid.

CINCEL PALA ANCHA HEXAGONAL 30MM **COD 0556**

DBC0324103 **PVP: 35,16 €**



- 30X410X100 mm
- Adecuado para PDB17008

EAN 6928073666333 25 unid.

PUNTERO HEXAGONAL 17 MM **COD 0449**

DBC0512801 **PVP: 6,10 €**



- 17 x 280 mm
- Adecuado para PDB13008

EAN 6928073666449 50 unid.

CINCEL HEXAGONAL 17 MM **COD 0450**

DBC0522801 **PVP: 6,10 €**



- 17 x 280 x 22 mm
- Adecuado para PDB13008

EAN 6928073666470 50 unid.

BLÍSTER 5 SIERRAS CALAR **COD 0324**

JBT101D **PVP: 3,35 €**



- Para madera
- Longitud del diente: 74 mm
- Espacio entre dientes: 4 - 5,2 mm
- Dientes rectificadas y cónicas • Paquete de 5 Pcs

EAN 6928073677575 25 unid.

BLÍSTER 5 SIERRAS CALAR **COD 0326**

JBT118B **PVP: 3,58 €**



- Para metal
- HSS
- Paquete de 5 Pcs
- Longitud del diente: 50 mm
- Espacio entre dientes: 1,9 - 2,3 mm
- Conjunto ondulado, fresado
- Chapa de espesor medio (2,5 - 6 mm)

EAN 6928073678183 25 unid.

BLÍSTER 5 SIERRAS CALAR **COD 0323**

JBT111C **PVP: 1,83 €**



- Basicamente para madera
- Longitud del diente: 74 mm
- 8TPI
- HCS, paquete de 5 Pcs

EAN 6928073669099 25 unid.

BLÍSTER 5 SIERRAS CALAR **COD 0325**

JBT244D **PVP: 2,77 €**



- 6TPI
- Para madera
- Paquete de 5 Pcs
- Longitud del diente: 74 mm
- HCS, juego lateral, madera blanda, madera blanda molida (5 - 50 mm), tableros aglomerados, madera contrachapados con núcleo de madera, tableros de fibra, especialmente para cortes curvados

EAN 6928073677780 25 unid.

BLÍSTER 5 SIERRAS CALAR SURTIDAS **COD 0327**

AKJ0051 **PVP: 3,05 €**



- 2 Pcs JBT111c para madera
- 2 Pcs JBT118b para metal
- 1 Pcs JBT127d para aluminio
- Paquete de 5 Pcs

EAN 6928073677582 25 unid.

BLÍSTER 2 SIERRAS SABLE

COD 0328

SSB644D

PVP: 1,66 €

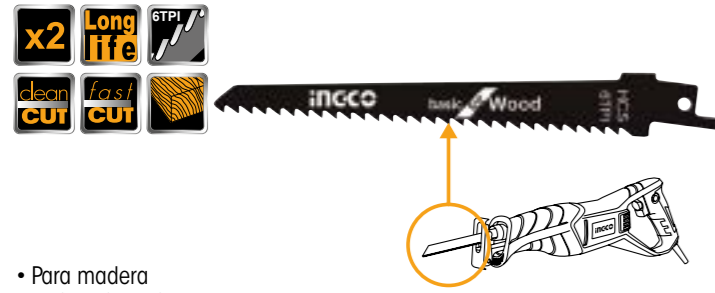

- Para madera
- 150 x 19 x 1,25 mm
- 6 TPI - HCS
- Diámetro < 100 mm
- Adecuado para RS8008
- 1/2" shank paquete de 2 Pcs
- Corte rápido para madera, materiales de composición y plástico

EAN 6928073673461 25 unid.

HOJAS ARCO DE SIERRA BIMETAL

COD 0451

HSBB12186

PVP: 1,56 €



- Medidas: 300 mm
- Bimetal: M42 + D6A
- Pack indivisible 10 unid.

EAN 6925582147407 10 unid.

BLÍSTER 5 LIJAS PARA FS35028

COD 0378

AKFS264115

PVP: 1,36 €



- Medidas:
- 5 pcs por blister
 - 3 Pcs P80 / 2 Pcs P120

EAN 6925582124934 25 unid.

BLÍSTER 2 SIERRAS SABLE

COD 0329

SSB922EF

PVP: 3,73 €



- Flexible
- 150 mm x 19 x 0,9 mm
- 18TPI - bi-metal - milled
- Adecuado para RS8008
- Paquete de 2 Pcs, 1/2" shank
- Corta todos los metales, incluidos los conductos no ferrosos (<100 mm), inoxidable y chapa rieles (1,5 - 4 mm)

EAN 6928073673478 25 unid.

BLÍSTER 5 LIJAS PARA FS3208

COD 0302

AKFS240101-1

PVP: 0,84 €



- Medidas:
- 5 pcs por blister
 - 3 Pcs P80 / 2 Pcs P120

EAN 6925582117738 25 unid.

BLÍSTER 5 LIJAS PARA CROSLI2001

COD 0560

AKRS125051

PVP: 1,69 €

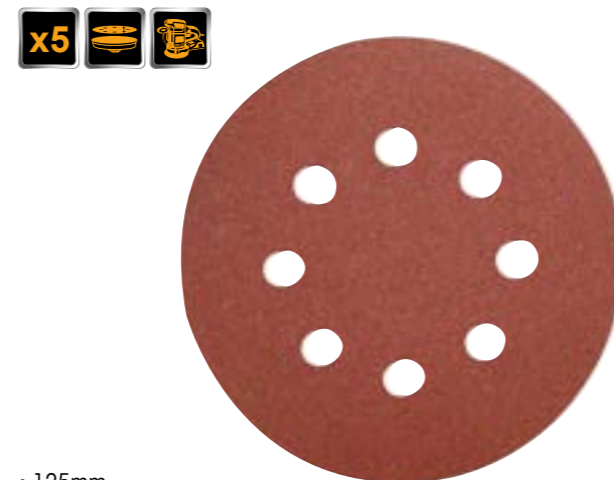

- 125mm
- 5 Pcs. por blister
- 3 Pcs P80 / 2 Pcs P120

EAN 6928073666395 20 unid.

BLÍSTER 5 LIJAS PARA RS4508

COD 0303

AKRS150051

PVP: 2,06 €



- 150 mm
- 5 Pcs. por blister
- 3 Pcs P80 / 2 Pcs P120

EAN 6928073671030 20 unid.

LIJA PARA LIJADORA DE MUROS

COD 0379

AKRS225061

PVP: 5,59 €



- Adecuado para DWS6003 y DWS10501
- 225 MM
- Plato 22
- P60, P80, P120, P150, P180, P240 (6 Lijas)

EAN 6925582113471 12 unid.

BLISTER 20 LIJAS MOUSE

COD 0773

AKTS080201

PVP: 3,24 €

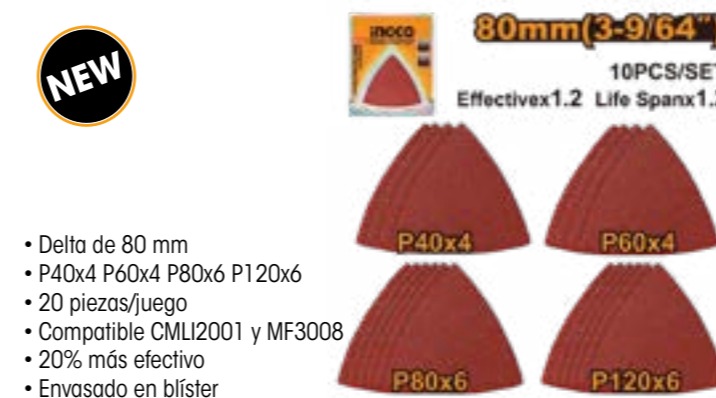

- Delta de 80 mm
- P40x4 P60x4 P80x6 P120x6
- 20 piezas/juego
- Compatible CMLI2001 y MF3008
- 20% más efectivo
- Envasado en blister

EAN 6941640163745 12 unid.

BLÍSTER 2 LIJAS PARA PBS12001

COD 0304

BSP020801

PVP: 3,37 €



- 100 x 610 mm
- P80 / 2 pcs por blister

EAN 6928073665770 10 unid.

RECAMBIO PULIDORA

COD 0452

APB0111801

PVP: 6,71 €



- Funda de lana
- Diámetro: 180 mm
- Blíster cartón

EAN 6928073670033 1 unid.

BLISTER 20 LIJAS MOUSE

COD 0774

AKTS080202

PVP: 3,96 €

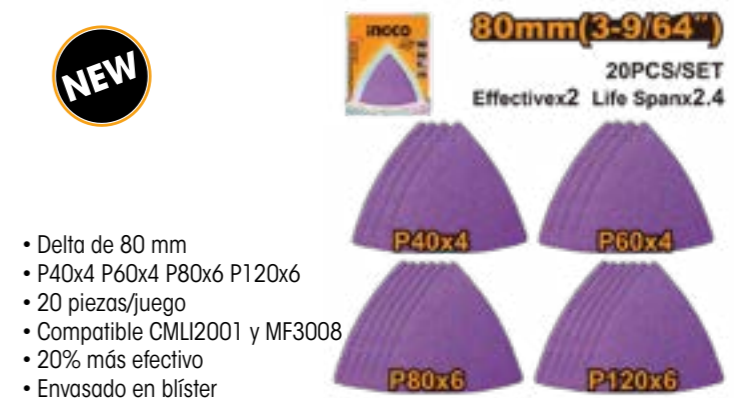

- Delta de 80 mm
- P40x4 P60x4 P80x6 P120x6
- 20 piezas/juego
- Compatible CMLI2001 y MF3008
- 20% más efectivo
- Envasado en blister

EAN 6941640166302 1 unid.

DISCO CORTE METAL-INOX 115 MM

MCD121155

COD 0522

PVP: 6,21 €



- DIÁMETRO: 115 mm
- DIÁMETRO INT: 22,2 mm
- ESPESOR: 1,2 mm
- VELOCIDAD: 13.300 rpm
- CAJA METÁLICA: 10 unidades

EAN 6925582115079 12 unid.

DISCO CORTE METAL-INOX 115 MM

MCD1211525

COD 0523

PVP: 14,03 €



- DIÁMETRO: 115 mm
- DIÁMETRO INT: 22,2 mm
- ESPESOR: 1,2 mm
- VELOCIDAD: 13.300 rpm
- CAJA METÁLICA: 25 unidades

EAN 6925582126730 12 unid.

DISCO CORTE METAL-INOX 115 MM

MCD1211550

COD 0524

PVP: 28,32 €



- DIÁMETRO: 115 mm
- DIÁMETRO INT: 22,2 mm
- ESPESOR: 1,2 mm
- VELOCIDAD: 13.300 rpm
- CAJA PLÁSTICO: 50 unidades

EAN 6925582146608 12 unid.

DISCO CORTE METAL-INOX 10 U. 125 MM

MCD121255

COD 0631

PVP: 8,55 €



- DIÁMETRO: 125 mm
- DIÁMETRO INT: 22,2 mm
- ESPESOR: 1,2 mm
- VELOCIDAD: 12.200 rpm
- CAJA METÁLICA: 10 unidades

EAN 6925582143881 40 unid.

DISCO CORTE FINO METAL-INOX 230MM

MCD3023003

COD 0632

PVP: 2,29 €



- DIÁMETRO: 230 mm
- DIÁMETRO INT: 22,2 mm
- ESPESOR: 1,9 mm
- VELOCIDAD: 6.650 rpm

EAN 6925582106206 50 unid.

UNIVERSAL SEGMENTADO

DMD01



- Corte seco y húmedo
- Blíster

EAN	REF	COD	1 unid.	PVP
6925582106442	DMD01-1151	0197	Diámetro 115	5,24 €
6928073665220	DMD01-1252	0198	Diámetro 125	5,34 €
6925582108804	DMD01-2301	0200	Diámetro 230	16,54 €

UNIVERSAL SEMI-SEGMENTADO

DMD03



- Corte seco y húmedo
- Blíster

EAN	REF	COD	1 unid.	P.V.C.
6925582108781	DMD03-1151	0205	Diámetro 115	5,60 €
6925582104028	DMD03-1252	0206	Diámetro 125	11,96 €
6925582108798	DMD03-2301	0208	Diámetro 230	18,32 €

JUEGO CORONAS BIMETAL MALETÍN DE ALUMINIO

AKH0121

PVP: 85,32 €

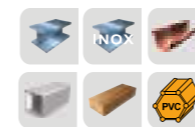

- Sierra de perforación: 12 piezas
- Tamaño: 20 mm / 22 mm / 25 mm / 29 mm / 32 mm / 35 mm / 38 mm / 44 mm / 48 mm / 50 mm
- Incluye 2 mandriles de alta calidad
- Maletín de aluminio

EAN 6928073663257 10 unid.

UNIVERSAL AZULEJOS

DMD02



- Corte húmedo
- Blíster

EAN	REF	COD	1 unid.	PVP
6925582106466	DMD02-1151	0201	Diámetro 115	4,74 €
6925582108453	DMD02-1252	0202	Diámetro 125	5,34 €
6925582108460	DMD02-2302	0204	Diámetro 230	14,52 €

JUEGO DE CORONAS

AKHS702

COD 0220

PVP: 6,22 €



- 7 piezas
- Diámetro del agujero: 26 mm / 32 mm / 38 mm / 45 mm / 50 mm / 56 mm / 63 mm
- Altura: 50 mm (2")
- Embalado con tarjeta de percha

EAN 6928073665442 10 unid.

CUCHILLA CORTADOR CERÁMICA

HTC04600B

COD 0348

PVP: 3,08 €



- Cortador de azulejos
- Material: carburo de tungsteno
- Adaptada para HTC04600

EAN 6925582119459 50 unid.

Tamaño cuchilla 16 x 6 x 3 mm

CUCHILLA CORTADOR CERÁMICA

HTC04800B

COD 0350

PVP: 7,90 €



- Hoja de corte para azulejos
- Rodamiento de bolas
- Material: carbón tungsteno
- Adaptada para HTC04800AG



EAN 6925582119633 1 unid.

Tamaño cuchilla 22 x 10,5 x 2 mm

HUSILLO HEXAGONAL PARA CORONA 14-30MM COD 0561
HSA01 PVP: 3,91 €



- Incluye broca piloto HSS
- Vástago hexagonal 3/8"

EAN	REF	COD	10 unid.	PVP
6928073664698				

CORONA BIMETAL



- Dientes endurecidos HSS

EAN	REF	COD	10 unid.	PVP
6928073667880	HSB10161	0563	Corte 16 mm	2,06 €
6928073664490	HSB10191	0564	Corte 19 mm	3,53 €
6928073667927	HSB10221	0565	Corte 22 mm	3,89 €
6928073667934	HSB10251	0566	Corte 25 mm	4,21 €
6928073667972	HSB10321	0567	Corte 32 mm	5,37 €
6928073668016	HSB10381	0568	Corte 38 mm	6,12 €

CEPILLO ABRASIVO COPA NYLON



- Vástago 1/4
- Velocidad 4500 rpm
- Filamento 1,2 mm

EAN	REF	COD	120 unid.	PVP
6925582152500	WB30505	0657	50 mm	2,59 €
6925582152517	WB30755	0658	75 mm	4,09 €

HUSILLO HEXAGONAL PARA CORONA 32-210MM COD 0562
HSA02 PVP: 8,69 €



- Incluye broca piloto HSS
- Vástago hexagonal 7/16"

EAN	REF	COD	12 unid.	PVP
6928073664704				

CORONA BIMETAL



- Dientes endurecidos HSS

EAN	REF	COD	10 unid.	PVP
6928073664537	HSB10461	0569	Corte 46 mm	7,45 €
6928073668061	HSB10511	0570	Corte 51 mm	8,17 €
6928073668115	HSB10641	0571	Corte 64 mm	10,13 €
6928073668139	HSB10681	0634	Corte 68 mm	11,75 €
6928073668160	HSB10761	0572	Corte 76 mm	12,27 €

CEPILLO ABRASIVO PLANO NYLON



- Vástago 1/4
- Velocidad 4500 rpm
- Filamento 1,2 mm

EAN	REF	COD	12 unid.	PVP
6925582152524	WB40755	0659	75 mm	3,25 €
6925582152531	WB41005	0660	100 mm	4,83 €

CEPILLO COPA ACERO LATONADO



- Vástago 1/4
- Velocidad 4500 rpm
- Filamento 0,3 mm

EAN	REF	COD	144 u./caja	50 mm	PVP
6928073661291	WB30501	0661			1,54 €
6928073661307	WB30751	0662	120 u./caja	75 mm	2,02 €

CEPILLO BROCHA ACERO LATONADO

WB70241

COD 0666

PVP: 1,48 €



- Vástago 1/4
- Velocidad 4500 rpm
- Alambre 0,3 mm
- Longitud alambre 25 mm
- Diámetro 25 mm

EAN	REF	COD	240 unid.
6928073666876			

CEPILLO COPA ACERO TRENZADO

WB21005

COD 0668

PVP: 6,24 €



- Rosca M 14
- Velocidad 12.500 rpm
- Alambre 0,5 mm
- Longitud alambre 30 mm
- Diámetro 100 mm

EAN	REF	COD	30 unid.
6941640109613			

CEPILLO PLANO ACERO LATONADO



- Vástago 1/4
- Velocidad 4500 rpm
- Filamento 0,3 mm

EAN	REF	COD	240 u./caja	50 mm	PVP
6928073669112	WB40501	0663			1,18 €
6928073666340	WB40751	0664	144 u./caja	75 mm	1,70 €
6928073661321	WB41001	0665	60 u./caja	100 mm	2,20 €

CEPILLO COPA ACERO LATONADO

WB11005

COD 0667

PVP: 5,67 €



- Rosca M 14
- Velocidad 8500 rpm
- Alambre 0,3 mm
- Longitud alambre 30 mm
- Diámetro 100 mm

EAN	REF	COD	30 unid.
6941640109552			

BROCA CAZOLETA 35MM PARA MADERA

ADCS3501

COD 0775

PVP: 5,40 €



EAN	REF	COD	30 unid.
69280073661420			

DISCO ABRASIVO LAMINAS DE ZIRCONIO



- Diámetro 115mm
- Grueso 22 mm

EAN	REF	COD	200 unid.	PVP
6941640160911	FDZ1151	0669	115P40	2,00 €
6941640155801	FDZ1152	0670	115P60	1,92 €
6941640160928	FDZ1153	0671	115 P80	1,92 €

SET DISCOS LIJA ZIRCONIO

COD 0675

AKRS125101

PVP: 4,08 €



- Diámetro 125mm
- 10 unidades
- 2 x P40, 2 x P60, 3 x P80, 2 x P120

EAN	6941640153173	40 unid.
-----	---------------	----------

CADENA MOTOSIERRA



EAN	REF	COD	50 unid.	P.V.C.
6941640141491	AGSC51001	0679	10"	11,99 €
6941640131263	AGSC51601	0680	16"	17,16 €
6941640133458	AGSC51801	0681	18"	18,39 €

HILO DESBROZADORA

COD 0704

ALS25405

PVP: 12,96 €



- Diámetro hilo 2,5 mm
- Longitud hilo 4 m

EAN	6941640145437	25 unid.
-----	---------------	----------

DISCO ABRASIVO LAMINAS DE ZIRCONIO



- Diámetro 125mm
- Grueso 22 mm

EAN	REF	COD	200 unid.	PVP
6941640166043	FDZ1251	0672	125 P40	2,36 €
6941640163509	FDZ1252	0673	125 P60	2,21 €
6941640168627	FDZ1253	0674	125 P80	2,21 €

SET DISCOS LIJA ZIRCONIO



- Diámetro 150 mm
- 10 unidades
- 2 x P800, 2 x P1000, 2 x P1200, 2 x P1500, 2 x P2000 (Cod. 676)
- 2 x P80, 1 x P120, 2 x P180, 2 x P240, 2 x P320, 1 x P400 (Cod. 677)
- 2 x P40, 2 x P60, 4 x P180, 2 x P120 (Cod. 678)

EAN	REF	COD	40 unid.	PVP
6928073671030	AKRS150101	0676	150 mm	5,51 €
6941640163394	AKRS150102	0677	150 mm	5,51 €
6941640150608	AKRS150103	0678	150 mm	5,51 €

ESPADA MOTOSIERRA



EAN	REF	COD	25 unid.	PVP
6941640146618	AGSB51001	0682	10"	10,93 €
6941640136381	AGSB51601	0683	16"	16,64 €
6941640131089	AGSB51801	0684	18"	18,01 €

CUCHILLA DESBROZADORA

COD 0705

ABC05

PVP: 8,36 €

- 3 Dientes
- Diámetro 255 mm

EAN	6941640138576	50 unid.
-----	---------------	----------

JUEGO DE FRESAS

COD 0376

AKRT1201

PVP: 26,63 €



- Diámetro eje 6 mm
- 12 unidades
- Tungsteno de alta calidad
- Caja madera

EAN	6928073667460	1 unid.
-----	---------------	---------

JUEGO 15 ACCESORIOS MULTIFUNCIONES

COD 0453

AKTMT1502

PVP: 14,76€

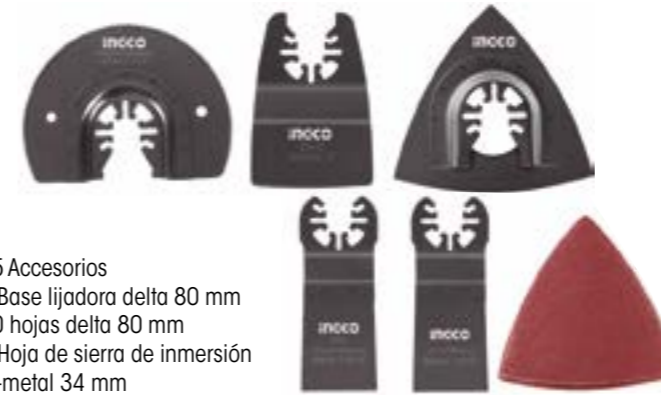

- 15 Accesorios
- 1 Base lijadora delta 80 mm
- 10 hojas delta 80 mm
- 1 Hoja de sierra de inmersión bi-metal 34 mm
- 1 Hoja de sierra de inmersión crv 34 mm
- 1 Hoja de sierra de segmento 87 mm
- 1 Cuchilla, rasqueta 50 mm

EAN	6925582132229	10 unid.
-----	---------------	----------

COLA TERMOFUSIBLE

COD 0454

AKTGS2061

PVP: 2,77 €



- Set 6 unidades.
- Largo: 20 cm.
- Diámetro: 11,2 mm.

EAN	6925582100761	10 unid.
-----	---------------	----------

JUEGO DE FRESAS

COD 0377

AKRT1211

PVP: 26,63 €



- Diametro eje 8mm
- 12 unidades
- Tungsteno de alta calidad
- Caja madera

EAN	6928073670798	1 unid.
-----	---------------	---------

BLISTER CUCHILLA CEPILLO

COD 0301

EPB820121

PVP: 4,36 €



- Tamaño: 82 x 5,5 x 1,2 mm
- Material: HSS
- incluye: 2 Pcs
- Doble blíster

EAN	6928083661352	1 unid.
-----	---------------	---------

COLA TERMOFUSIBLE

COD 0776

AKTGS3011

PVP: 15,58 €



- 1 KG Cola
- Largo: 300mm
- Diámetro: 11,2mm

EAN	6928073714447	1 unid.
-----	---------------	---------

GRAPA 530/10

COD 0573

STS0110

PVP: 1,01 €

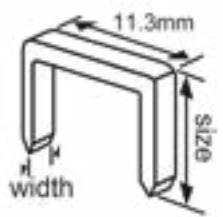

- Set 1000 Pcs
- 530/10
- Medida exterior 11,30 mm
- Medida interior 10 mm
- Grueso 0,7 mm

EAN	6925582101669	1 unid.
-----	---------------	---------

CLAVO BRAD 25mm **COD 0574**
ANA18251 **PVP: 6,03 €**

- Set 5000 Pcs
- Ga 18, 1,25x1mm

EAN 6928073670729  10 unid.



CLAVO BRAD 30mm **COD 0575**
ANA18301 **PVP: 6,42 €**

- Set 5000 Pcs
- Ga 18, 1,25x1mm

EAN 6928073712429  10 unid.



CLAVO BRAD 35mm **COD 0576**
ANA18351 **PVP: 7,61 €**

- Set 5000 Pcs
- Ga 18, 1,25x1mm

EAN 6928073667439  10 unid.



CLAVO BRAD 40mm **COD 0577**
ANA18401 **PVP: 8,53 €**

- Set 5000 Pcs
- Ga 18, 1,25x1mm

EAN 6928073670736  10 unid.



CLAVO BRAD 50mm **COD 0578**
ANA18501 **PVP: 10,94 €**

- Set 5000 Pcs
- Ga 18, 1,25x1mm

EAN 6928073670743  10 unid.



GRAPA 25mm **COD 0579**
AST18251 **PVP: 6,37 €**

- Set 2500 Pcs
- Ga 18, 1,25x1mm
- Ancho grapa 5,7mm

EAN 6928073667446  10 unid.



GRAPA 35mm **COD 0580**
AST18351 **PVP: 8,67 €**

- Set 2500 Pcs
- Ga 18, 1,25x1mm
- Ancho grapa 5,7mm

EAN 6928073670699  10 unid.



GRAPA 40mm **COD 0581**
AST18401 **PVP: 9,43 €**

- Set 2500 Pcs
- Ga 18, 1,25x1mm
- Ancho grapa 5,7mm

EAN 6928073667453  10 unid.



PILA ALCALINA LR03 AAA (BL4) **COD 0599**
HAB3A01 **PVP: 1,36 €**



- Blíster 4 unidades
- Expositor 75 blisters 300 unidades
- Capacidad 1300 mAh

EAN 6925582142037  1 unid.

PILA ALCALINA LR6 AA (BL4) **COD 0600**
HAB2A01 **PVP: 1,64 €**



- Blíster 4 unidades
- Expositor 32 blisters 128 unidades
- Capacidad 2900 mAh

EAN 6925582139716  1 unid.

HERRAMIENTA MANUAL

CATÁLOGO 2023

CARRO TALLER 162 PCS

COD 0308

HTCS271621

PVP: 1256,98 €

- INCLUYE
- 7 cajónes
- Tamaño 765 x 465 x 812mm
- Herramientas

- CAJÓN 1
- 1 Pcs llave de trinquete 1/4"
- 13 Pcs 1/4" socket 4 - 4,5 - 5 - 5,5 - 6 - 7 - 8 - 9 - 10 - 11 - 12 - 13 - 14
- 17 Pcs 1/4" x 32(l) bits socket :hex: 3 - 4 - 5 - 6mm star:t8 - t10 - t15 - t20 - t25 - t30 sl: 4 - 5,5 - 7 mm, ph1, ph2, pz2
- 8 Pcs 1/4" dr 50 mm(l) deep socket: 6 - 7 - 8 - 9 - 10 - 11 - 12 - 13 mm
- 2 Pcs extension bar: 1/4" dr. x 50 mm, 1/4" dr. x 100 mm
- 1 Pcs spinner handle: 1/4" x 150 mm
- 1 Pcs extension flexible bar :1/4" x 150 mm
- 1 Pcs 1/4" universal joint
- 1 Pcs sliding "t" bar: 1/4" x 114 mm
- 1 Pcs ratchet wrench: 1/2"
- 1 Pcs 1/2" universal joint
- 19 Pcs 1/2" dr socket: 8 - 10 - 11 - 12 - 13 - 14 - 15 - 16 - 17 - 18 - 19 - 20 - 21 - 22 - 23 - 24 - 27 - 30 - 32 mm
- 4 Pcs 1/2" dr 77 mm(l) deep socket: 14 - 15 - 17 - 19 mm
- 5 Pcs 1/2" star socket: e10 12 14 16 20
- 2 Pcs spark plug socket: 1/2" dr. 16mm -21mm
- 1 Pcs 1/2" * 250 mm sliding t bar
- 2 Pcs extension bar: 1/2" dr. x 125mm - 1/2" dr. x 250mm

- CAJÓN 2
- 14 Pcs screwdriver sl3* 75,sl4* 100,sl5,5* 100,sl6,5* 38,sl6,5* 125,sl6,5* 150,sl8* 200,ph0* 75 ph1* 75,ph1*100,ph2* 38,ph2* 125,ph2* 150,ph3* 200
- 4pcs t-handle hex wrench: 3x100mm,4x100mm,5x150mm,6x150mm
- 1pcs flashlight

- CAJÓN 3
- 17 Pcs combination spanner: 6 - 7 - 8 - 9 - 10 - 11 - 12 - 13 - 14 - 15 - 16 - 17 - 18 - 19 - 21 - 22 - 24
- 5 Pcs flare nut spanner 8* 10 10* 12, 11* 13, 12* 14, 17* 19
- 9 Pcs hex key wrench: 1,5 - 2 - 2,5 - 3 - 4 - 5 - 6 - 8 - 10
- 9 Pcs trox key wrench: t10 - t15 - t20 - t25 - t27 - t30 - t40 - t4 - t50

- CAJÓN 4
- 1 Pcs 10" curved jaw lock wrench
- 1 Pcs 40 mm rubber and plastic hammer
- 1 Pcs 10" water pump pliers
- 1 Pcs 8" combination pliers
- 1 Pcs 6" long nose pliers
- 1 Pcs 7" diagonal cutting pliers
- 1 Pcs utility knife
- 4 Pcs circlip pliers
- 1 Pcs 300 g machinist hammer
- 1 Pcs 10" adjustable wrench
- 1 Pcs 5 x 19mm steel measuring tape

- CAJÓN 5
- 1 Pcs spirit level (with powerful magnets)
- 1 Pcs hacksaw frame
- 1 Pcs mechanic gloves
- 5 Pcs iron hooks for hanger tools

- CAJÓN 6 (vacío)
- CAJÓN 7 (vacío)
- Empaquetado con goma eva + caja cartón + palet



EAN 6925582126815 1 unid.

MALETA DE HERRAMIENTAS 77 PCS

COD 0053

HKTHP20771

PVP: 160,25 €

- DIN 3122
- Cr-V 50BV3 0 1/2"
- DIN 3123
- DIN 3124
- 1/4"
- 45T



- Llaves combinadas, alicate universal, alicate corte diagonal, destornilladores, vasos, martillo, llaves allen, puntas.
- Maleta BMC

EAN 6925582114515 4 unid.

MALETA DE HERRAMIENTAS 25 PCS

COD 0055

HKTS12251

PVP: 86,53 €

- DIN 3122
- DIN 3123
- DIN 3124
- Cr-V 50BV3 0 1/2"
- 45T



- Juego de llaves de vaso de 1/2"
- Uso intensivo, vasos hasta 32 mm, alargadera, rótula, mango corredero, etc.
- Maleta BMC

EAN 6928073673294 4 unid.

MALETA DE HERRAMIENTAS 45 PCS

COD 0054

HKTS14451

PVP: 41,59 €

- DIN 3122
- DIN 3123
- DIN 3124
- Cr-V 50BV3 0 1/4"
- 45T



- Juego de 45 piezas
- Llaves de vaso de 1/4", puntas, vasos, alargaderas, rótula, mango corredizo, etc.
- Maleta BMC

EAN 6928073673287 6 unid.

MALETA DE HERRAMIENTAS 44 PCS

COD 0056

HKTS42441

PVP: 109,57 €

- DIN 3122
- DIN 3123
- DIN 3124
- Cr-V 50BV3 0 1/2"
- 1/4"
- 45T



- Juego de llaves de vaso de 1/2 - 1/4"
- Uso intensivo, vasos hasta 3 mm, alargaderas, rótulas, mango corredero, etc.
- Maleta BMC

EAN 6925582115741 4 unid.

MALETA DE HERRAMIENTAS 94 PCS

COD 0057

HKTS42941

PVP: 165,09 €



- Juego de llaves de vaso de 1/2 - 1/4
- Uso intensivo, vasos hasta 32 mm
- Alargaderas, puntas, mango corredero, etc.
- Maleta BMC

EAN 6925582103243 2 unid.

MALETA DE HERRAMIENTAS 142 PCS

COD 0058

HKTHP21421

PVP: 298,43 €



- Juego de llaves de vaso de 1/2 - 1/4 - 3/8
- incluye: alicates, mordaza, martillo, puntas, llaves Allen, destornilladores, etc.
- Maleta BMC

EAN 6925582115666 1 unid.

MALETA HERRAMIENTAS 20 PCS 1/4"

COD 0808

HKTS14201

PVP: 21,40 €

- 20 Pcs 1/4
- Material: CR-V (50BV30)
- Maleta BMC



- 1 pcs 1/4" DR. Llave carraca, 45T
- 13 pcs 1/4" DR. Vasos: 4, 4.5, 5, 5.5, 6, 7, 8, 9, 10, 11, 12, 13, 14 mm
- 1 pcs 1/4" DR. Extension 2" (50mm)
- 1 pcs 1/4" DR. Destornillador 1/4
- 4 pcs 1/4" DR. Vasos extralargos: 8, 10, 12, 13 mm
- 1 pcs 1/4" DR. Llave carraca, 45T

EAN 6941640175458 2 unid.

CAJA DE HERRAMIENTAS METÁLICA

COD 0063

HTB02

PVP: 77,00 €



- Medidas: 495 x 200 x 290 mm

EAN 692807366869 1 unid.

MALETA HERRAMIENTAS 20 PCS 1/2"

COD 0809

HKTS12201

PVP: 46,90 €

- 20 Pcs 1/2
- Material: CR-V (50BV30)
- Maleta BMC



- 1 pcs 1/2" DR. Llave carraca, 45T
- 12 pcs 1/2" DR. Vasos: 10, 11, 12, 13, 14, 15, 16, 17, 18, 19, 22, 24 mm
- 1 pcs 1/2" DR. Vaso bujía: 16 mm
- 1 pcs 1/2" DR. Adaptador universal
- 1 pcs 1/2" DR. Extensión: 10" (250mm)
- 1 pcs 1/2" DR. Articulación
- 3 pcs 1/2" DR. Vasos extra-largos: 13, 17, 19 mm

EAN 6941640185921 1 unid.

CAJA DE HERRAMIENTAS METÁLICA

COD 0062

HTB03

PVP: 49,32 €



- Medidas: 400 x 200 x 195 mm

EAN 6928073671979 1 unid.

BOLSA PORTAMÁQUINAS INGCO

COD 0439

HTBG28131

PVP: 8,56 €



- Tela
- Base reforzada
- Máxima apertura, varilla interior
- Medidas: 33 x 18 x 22 cm

EAN 6925582135404 20 unid.

BOLSA PORTAMÁQUINAS INGCO

COD 0546

HTBG28161

PVP: 14,35 €



- Tela
- Base reforzada
- Máxima apertura, varilla interior
- Medidas: 41 x 22 x 27 cm.

EAN 6925582135411 10 unid.

CAJA DE HERRAMIENTAS 147 PCS

COD 0582

HKTHP21471

PVP: 295,10 €

Caja aluminio, con carro Incluye:

- 1 Lima de acero semicircular 200mm
- 1 Nivel 40cm
- 1 Martillo de maquinista 300g
- 1 Sierra de arco para metales de 300 mm
- 1 Cinta métrica de acero 5M
- 1 Set 9pcs Llave allen 1.5 / 2 / 2.5 / 3/4/5/6/8/10
- 1 Alicata universal 180mm
- 1 Alicates de punta larga 160mm
- 1 Alicata corte diagonal de 160mm
- 1 Alicata universal de 220 mm
- 1 Llave stilson 250mm
- 1 Llave ajustable de 200mm
- 1 Mordaza de bloqueo curva de 250mm
- 1 Tijeras de 220mm
- 9 Piezas Llave combinadas 6/8/10/12/14/15/17/19/22
- 4 Destornillador punta plana SL8 * 150 / SL6* 125 / SL5* 100 / SL6.5* 38
- 3 Destornillador Phillips PH2 * 150 / PH1* 100 / PH2 * 38
- 1 Pieza de vástago magnético de 1/4"
- 2 Destornillador aislado electricista SL5* 125 / PH2* 100
- 1 Detector de corriente
- 1 Llave carraca de 1/2", 45 dientes
- 1 Llave carraca de 1/4", 45 dientes
- 1 Mango giratorio de 1/4" * 150 mm
- 1 barra de extensión flexible de 1/4" * 150 mm



- 1 Adaptador de tres vías 1/2" (F) * 3/8" (M)
- 1 Articulación universal 1/2"
- 1 Articulación universal 1/4"
- 2 Barras de extensión 1/2": 150 mm (5") 250 mm (10")
- 2 Barras de extensión 1/4": 50 mm (2") 100 mm (4")
- 18 pcs 1/2" Vaso hexagonal: 10, 11, 12, 13, 14, 15, 16, 17, 18, 19, 20, 21, 22, 23, 24, 27, 30, 32
- 13 piezas 1/2" Vaso hexagonal: 4 / 4.5 / 5 / 5.5 / 6/7/8/9/10/11/12/13 / 14mm
- 2 pcs 1/2" Vaso de bujía: 16 mm / 21 mm
- 1 Cutter manual

- 1 Juego de cuchillas 10 pcs
- 1 Barra flexible de extensión de 1/4" x 150 mm
- 1 soporte para puntas de 1/4"
- 20 Puntas atornillar: SL3 / SL4 / SL5 / SL6 / PH0 / PH1 / PH2 / PH3 / PZ0 / PZ1 / PZ2 / PZ3 / T10 / T15 / T20 / T30 / H3 / H4 / H5 / H6
- 26 piezas: Tornillo madera de 2,0 mm* 6 piezas / 2,5 mm* 6 piezas; Tornillo autorroscante 2,5 mm* 7 piezas / 5 mm* 7 piezas
- 1 Soporte magnético para brocas

EAN 6941640124791 1 unid.

MOCHILA PORTA-HERRAMIENTAS

COD 0777

HBP0101

PVP: 36,04 €



340x170x450mm
18"x13.8"x8.8"



Max Load 8 kgs

- Tamaño: L34 x W17 x H45cm
- Con 1 bolsa de asa en el interior.
- Carga máxima: 8 kg
- Material: poliéster oxford 600D
- Marco rígido para fácil apertura y acceso Interno
- Bolsillos externos para capacidad de almacenamiento adicional

EAN 6925582143058 1 unid.

DELANTAL PORTAHERRAMIENTAS

COD 0455

HTBP01011



PVP: 14,15 €

- Poliéster 600 deniers
- Costuras reforzadas
- 10 bolsillos
- Mosquetón metálico
- Medidas: 32 x 28 cm

EAN 6925582102925 20 unid.

PORTAHERRAMIENTAS

COD 0583

HTBP04011



PVP: 3,50 €

- Poliéster 600 deniers
- Costuras reforzadas
- 4 bolsillos
- Medidas 24 x 13 cm

EAN 6941640119698 6 unid.

ALICATE UNIVERSAL

COD 0234

HHCP28180



PVP: 7,62 €

- Mango largo 30% más de fuerza
- 180 mm

EAN 6925582122770 6 unid.

ALICATE UNIVERSAL

COD 0346

HHCP28240



PVP: 12,50 €

- Tamaño: 9.5" / 240 mm
- CR-V acabado pulido en negro
- TPR mango de dos colores
- Mango largo 30% más de fuerza

EAN 6925582120615 6 unid.

CINTURÓN PORTAHERRAMIENTAS

COD 0456

HTBP02031



PVP: 16,78 €

- Poliéster 600 deniers
- Costuras reforzadas
- 14 bolsillos
- 2 Pcs de 26 x 23 cm y 1 pcs 15 x 13
- Ajustable: 92 - 127 cm

EAN 6925582102932 10 unid.

PORTAHERRAMIENTAS CON CINTURÓN

COD 0584

HTBP03011



PVP: 6,21 €

- Poliéster 600 deniers
- Costuras reforzadas
- 1 bolsillo grande para taladro
- 5 bolsillos exteriores
- Medidas 29 x 19 cm

EAN 6941640119681 6 unid.

ALICATE UNIVERSAL

COD 0381

HHCP28200



PVP: 8,47 €

- Mango largo 30% más de fuerza
- 200 mm

EAN 6925582117578 6 unid.

ALICATE CORTE FRONTAL

COD 0778

HECP28160



PVP: 6,68 €

- Mango largo 30% más de fuerza
- 160 mm

EAN 6928073676110 6 unid.

ALICATE CORTE DIAGONAL

COD 0380

HHLDCP28160



PVP: 6,86 €

- Mango largo 30% más de fuerza
- 160 mm

EAN 6925582122787 6 unid.

ALICATE CORTE DIAGONAL

COD 0383

HHHDCP28180



PVP: 7,78 €

- Mango largo 30% más de fuerza
- 180 mm

EAN 6925582123098 6 unid.

ALICATE BOCA SEMI REDONDA LARGA

COD 0235

HHLNP28200



PVP: 7,17 €

- Mango fibra INGCO
- Mango largo 30% más de fuerza
- 200 mm

EAN 6925582122596 6 unid.

ALICATE CORTE DIAGONAL

COD 0382

HHLDCP28180



PVP: 7,30 €

- Mango largo 30% más de fuerza
- 180 mm

EAN 6925582117585 6 unid.

ALICATE BOCA SEMI REDONDA LARGA

COD 0231

HHLNP28160



PVP: 6,39 €

- Mango fibra I
- Mango largo 30% más de fuerza
- 160 mm

EAN 6925582117592 6 unid.

MINI CORTAVARILLAS

COD 0457

HMBC0808



PVP: 6,36 €

- Mango fibra INGCO
- Medida: 200 mm

EAN 6925582121551 6 unid.

ALICATE PELACABLES COD 0384
HWSP28160 PVP: 6,75 €



- Mango fibra INGCO
- Medida: 160 mm

EAN 6928073680148 6 unid.

PELACABLES 0,5 - 6 MM COD 0107
HWSP15608 PVP: 11,31 €



- Función de corte incorporada

EAN 6925582118285 12 unid.

ALICATE UNIVERSAL ELECTRICISTA COD 0593
HICP28168 PVP: 9,28 €



- Aislado 1000 V
- Certificado VDE
- 160 mm

EAN 6925582138931 6 unid.

ALICATE UNIVERSAL ELECTRICISTA COD 0594
HICP28188 PVP: 10,09 €



- Aislado 1000 V
- Certificado VDE
- 180 mm

EAN 6925582139006 6 unid.

TIJERA ELECTRICISTA COD 0525
HES02855 PVP: 3,56 €



- Cuchillas acero inoxidable 3mm
- Medida 145mm
- Mango ABS ergonómico

EAN 6925582149098 25 unid.

JUEGO ALICATES 3 PCS COD 0066
HKPS28318 PVP: 19,22 €



- Alicate universal 8" 200 mm
- Alicate corte diagonal 6" 160 mm
- Alicate boca semi-redonda 6" 160 mm

EAN 6925582120547 5 unid.

ALICATE UNIVERSAL ELECTRICISTA COD 0595
HICP28208 PVP: 11,20 €



- Aislado 1000 V
- Certificado VDE
- 200 mm

EAN 6925582138986 6 unid.

ALICATE CORTE DIAGONAL ELECTRICISTA COD 0596
HIHLDCP28160 PVP: 9,86 €



- Aislado 1000 V
- Certificado VDE
- 160 mm

EAN 6925582138979 6 unid.

TIJERA ELECT. AISLADA COD 0630
HIS1601 PVP: 16,69 €



- Aislado 1000 V
- Certificado VDE
- Medida 160 mm
- Mango ABS ergonómico

EAN 6941640165572 72 unid.

JUEGO MINI-ALICATES 6 PCS COD 0067
HMPS06115 PVP: 16,52 €



- Alicate universal
- Alicate corte diagonal
- Alicate corte frontal
- Alicate boca plana
- Alicate boc a semi-redonda
- Alicate boca semi-redonda larga
- Mango fibra INGCO

EAN 6941640112613 5 unid.

ALICATE CORTE DIAGONAL ELECTRICISTA COD 0597
HIHDCP28188 PVP: 10,27 €



- Aislado 1000 V
- Certificado VDE
- 180 mm

EAN 6925582138993 6 unid.

JUEGO ALICATE COD 0598
HIKPS28318 PVP: 27,32 €



- Aislado 1000 V
- Certificado VDE
- Alicate universal 200mm
- Alicate corte diagonal 160mm
- Alicate boca semi redonda 160mm

EAN 6925582145984 5 unid.

JUEGO ALICATES COD 0279
HKHLPS2831 PVP: 20,86 €



- Alicate universal 200 mm
- Alicate corte diagonal 160 mm
- Alicate punta larga: 160 mm
- Mango largo con un 30% más de fuerza

EAN 6925582118032 5 unid.

ALICATE ARO SEEGER EXTERIOR RECTO COD 0779
HCCP261801 PVP: 8,20 €



- Alicates para aros seeger de cabeza recta
- Pinza para arandelas exteriores

EAN	6941640161901		6 unid.
Tamaño:	7"/180 mm		
Diámetro de la cabeza:	1,8 mm		

ALICATE ARO SEEGER INTERIOR RECTO COD 0781
HCCP261803 PVP: 8,20 €



- Alicates para aros seeger de cabeza recta
- Pinza para arandelas interiores

EAN	6941640164452		6 unid.
Tamaño:	7"/180 mm		
Diámetro de la cabeza:	1,8 mm		

JUEGO ALICATES AROS SEGER COD 0068
HCCPS01180 PVP: 18,47 €

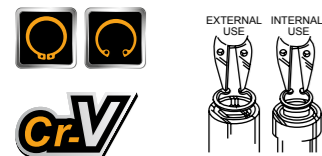

- Alicates interior recto
- Alicates interior curvo
- Alicates exterior recto
- Alicates exterior curvo
- Mango fibra INGCO

EAN	6925582101621		5 unid.
-----	---------------	--	---------

ALICATE ARO SEEGER EXTERIOR ACODADO COD 0780
HCCP261802 PVP: 8,25 €



- Alicates para aros seeger de cabeza acodada
- Pinza para arandelas exteriores

EAN	6941640154224		6 unid.
Tamaño:	7"/180 mm		
Diámetro de la cabeza:	1,8 mm		

ALICATE ARO SEEGER INTERIOR ACODADO COD 0782
HCCP261804 PVP: 8,25 €



- Alicates para aros seeger de cabeza acodada
- Pinza para arandelas interiores

EAN	6941640156778		6 unid.
Tamaño:	7"/180 mm		
Diámetro de la cabeza:	1,8 mm		

TENAZA PICO LORO COD 0458
HPP28251 PVP: 8,15 €



- Mango fibra INGCO

EAN	6925582132281		6 unid.
Longitud	250 mm		
Apertura máx.	50 mm		

TENAZA RUSA COD 0264
HRP02200 PVP: 5,21 €



EAN	6928073675472		6 unid.
Longitud	200 mm		

MORDAZA CURVA ALICATES DE BLOQUEO COD 0236
HCJLW0110 PVP: 9,87 €



- Cr-V
- HRC52 - HRC60
- Níquel plateado

EAN	6925582100617		5 unid.
Tamaño	10"		

TENAZA PICO LORO COD 0233
HPP28258 PVP: 8,06 €



- Mango fibra INGCO

EAN	6925582130720		6 unid.
Longitud	250 mm		
Apertura máx.	40 mm		

TENAZA RUSA COD 0265
HRP02250 PVP: 7,07 €



EAN	6928073675496		6 unid.
Longitud	250 mm		

MORDAZA SEMI CURVA ALICATES DE BLOQUEO COD 0385
HSJP0110 PVP: 6,40 €



- Cr-V
- Níquel plateado

EAN	6925582100648		5 unid.
Tamaño	10"		

MARTILLO MAQUINISTA



Drop forged

- Mango fibra de vidrio INGCO

PESO	EAN	REF	COD	unid.	PVP
100 g	6925582123708	HMH880100	0386	6	3,72 €
200 g	6925582123715	HMH880200	0387	6	3,94 €
300 g	6941640158116	HMH583001	0388	6	4,40 €
500 g	6925582122114	HMH880500	0389	6	5,96 €
1.000 g	6925582122121	HMH881000	0390	4	9,89 €
1.500 g	6925582122138	HMH881500	0391	4	12,55 €

MARTILLO DE OREJAS



Drop forged

- Mango fibra de vidrio INGCO

PESO	EAN	REF	COD	unid.	PVP
8 oz / 220 g	6925582122084	HCH80808	0414	6	4,54 €
16 oz / 450 g	6941640152978	HCH58016	0221	6	6,42 €
20 oz / 560 g	6925582132441	HCH80820	0585	6	7,36 €

MAZA DE GOMA



- Mango fibra de vidrio INGCO

PESO	EAN	REF	COD	unid.	PVP
8 oz / 220 g	6925582105704	HRUH8208	0224	10	4,29 €
16 oz / 450 g	6925582105711	HRUH8216	0225	6	6,16 €

MARTILLO DE BOLA



Drop forged

- Mango fibra de vidrio INGCO

PESO	EAN	REF	COD	unid.	PVP
16 oz / 450 g	6941640150431	HBPHS8016	0222	6	6,21 €
24 oz / 660 g	6925582122909	HBPH88024	0223	6	8,35 €

MARTILLO CAUCHO Y PLÁSTICO

HRPH8140

COD 0226

PVP: 8,86 €



- Diámetro martillo: 40 mm
- Mango fibra de vidrio INGCO

EAN	REF	unid.
6928073713259		10 unid.

MAZA DE GOMA BLANCA



- Mango fibra de vidrio INGCO

PESO	EAN	REF	COD	unid.	PVP
8 oz / 220 g	6928073713549	HRUH8308	0586	6	5,90 €
16 oz / 450 g	6925582105735	HRUH8316	0587	4	8,38 €

MACETA



Drop forged

- Cabeza forjada
- Mango fibra de vidrio INGCO

PESO	EAN	REF	COD	unid.	PVP
1.000 g	6941640163226	HSTH581000	0305	6	8,25 €
1.500 g	6925582122886	HSTH8803	0306	4	11,67 €
2.000 g	6925582122893	HSTH8804	0307	4	13,69 €

MAZA DOS MANOS 4 KG (900 mm)

HSTH03498

COD 0392

PVP: 36,19 €



- Peso: 4 kg
- Mango fibra de vidrio INGCO

EAN	REF	unid.
6925582119282		4 unid.

CINCEL

HCCL082210

COD 0247

PVP: 4,22 €



- Empuñadura INGCO
- Acero forjado

EAN	REF	unid.
6925582117257		6 unid.
Ancho pala		22 mm
Diámetro varilla		16 mm
Longitud		250 mm

MAZA DOS MANOS 5 KG (900 MM)

HSTH03598

COD 0228

PVP: 41,09 €



- Peso: 5 kg
- Mango fibra de vidrio INGCO

EAN	REF	unid.
6925582119299		4 unid.

HACHA

HAX5206001

COD 0227

PVP: 9,71 €



- Peso de la cabeza: 600 g
- Tratamiento térmico de martillo forjado en 45 de fibra de vidrio de acero al carbono
- Longitud: 360 mm

EAN	REF	unid.
6941640168061		6 unid.

CINCEL

HCCL082412

COD 0248

PVP: 5,43 €



- Empuñadura INGCO
- Acero forjado

EAN	REF	unid.
6925582117189		6 unid.
Ancho pala		25 mm
Diámetro varilla		18 mm
Longitud		300 mm

CINCEL **COD 0588**
 HCCL851916 **PVP: 7,32 €**



- Empuñadura INGCO PRO
- Acero forjado
- Ancho pala 19mm
- Diámetro varilla 16mm
- Longitud 305mm

EAN	6925582144987		5 unid.
Ancho pala	19 mm		
Diámetro varilla	16 mm		
Longitud	305 mm		

PUNTERO **COD 0685**
 HCC850419 **PVP: 8,64 €**



- Empuñadura INGCO PRO
- Acero forjado
- Diámetro varilla 19mm
- Longitud 305 mm

EAN	6925582145410		24 unid.
-----	---------------	--	----------

CORTADOR CERÁMICA **COD 0347**
 HTC04600 **PVP: 66,71 €**



- Cortador de azulejos
- Con 2 Pcs de hoja de carburo de tungsteno
- Multifunción: corte de línea directa corte de línea diagonal

EAN	6925582104455		4 unid.
Longitud máxima de corte	600 mm		
Espesor máximo de corte	12 mm		
Tamaño base	815 x 195 cm		
Espesor base	2 mm		
Tamaño cuchilla	16 x 6 x 3 mm		
Diámetro de barra deslizante	19 mm		

RECAMBIO CUCHILLA CORTADOR CERÁMICA **COD 0348**
 HTC04600B **PVP: 3,08 €**

EAN	6925582119459		50 unid.
-----	---------------	--	----------



CINCEL **COD 0589**
 HCCL852519 **PVP: 8,64 €**



- Empuñadura INGCO PRO
- Acero forjado
- Ancho pala 25mm
- Diámetro varilla 19mm
- Longitud 305mm

EAN	6925582145403		5 unid.
Ancho pala	25 mm		
Diámetro varilla	19 mm		
Longitud	305 mm		

CINCEL **COD 0250**
 HCCL844410 **PVP: 12,94 €**



- Empuñadura INGCO PRO
- Acero forjado

EAN	6925582110821		6 unid.
Ancho pala	44 mm		
Diámetro varilla	19 mm		
Longitud	215 mm		

CINCEL EXTRA-ANCHO **COD 0251**
 HCCL837610 **PVP: 18,16 €**



- Empuñadura INGCO PRO
- Acero forjado

EAN	6925582110814		4 unid.
Ancho pala	76 mm		
Diámetro varilla	19 mm		
Longitud	215 mm		

CORTADOR CERÁMICA **COD 0349**
 HTC04800AG **PVP: 146,61 €**



- Bolsa transporte
- Placa de aluminio
- Corte de línea diagonal
- Con indicador de aluminio
- 2Pcs de soporte de acero
- Embalado en caja de cartón
- Multifunción: corte de línea directa,
- 1Pcs de carburo tungsteno tamaño: 22 x 10,5 x 2 mm

EAN	6925582121162		1 unid.
Longitud máxima de corte	800 mm		
Espesor máximo de corte	14 mm		
Tamaño de corte	800 mm		
Espesor base	2,5 mm		
Tamaño cuchilla	16 x 6 x 3 mm		
Tamaño de la base	993 x 165 mm		

CUCHILLA CORTADOR CERÁMICA **COD 0350**
 HTC04800B **PVP: 7,91 €**

EAN	6925582119633		50 unid.
-----	---------------	--	----------



PALANCA DESENCOFRADOR



- Gancho y palanca con uñas biseladas
- Barra de acero forjado templado para mayor durabilidad
- Su diseño trilobular potencia su dureza, resistencia y facilidad de uso

MEDIDAS	EAN	REF	COD	unid.	PVP
35 cm	6928073713808	HWBA01142	0459	6	5,71 €
60 cm	6928073711620	HWBA01242	0460	6	14,36 €
90 cm	6928073713815	HWBA01362	0461	6	20,00 €

PALETA MODELO NORTE **COD 0464**
 HBT738 **PVP: 4,22 €**



- Medida: 180 mm
- Mango fibra INGCO

EAN	6925582127294		12 unid.
-----	---------------	--	----------

LLANA RECTA INOXIDABLE **COD 0466**
 HPT28138S **PVP: 10,49 €**



EAN	6925582123036		10 unid.
Medidas	280 x 130 mm		

PALETA



- Mango fibra INGCO

MEDIDAS	EAN	REF	COD	unid.	PVP
150 mm	6925582118063	HBT618	0462	10	3,34 €
180 mm	6925582118100	HBT718	0463	10	3,44 €

PALETA MODELO MADRID **COD 0465**
 HBT748 **PVP: 4,50 €**



- Medida: 180 mm
- Mango fibra INGCO

EAN	6925582123210		12 unid.
-----	---------------	--	----------

LLANA DENTADA INOXIDABLE **COD 0467**
 HPTT28138S **PVP: 10,52 €**



EAN	6925582123043		10 unid.
Medidas	280 x 130 mm		
Dientes	10 mm		

LLANA DE GOMA ESPONJA
HSFR24108

COD 0591
PVP: 7,84 €



- Base de aluminio y goma blanda

EAN	6925582128147		10 unid.
Medidas	240 x 100 mm		

LLANA ACERO
HPT231025

COD 0686
PVP: 3,57 €



- Medidas 230 x 100 mm

EAN	6941640153081		10 unid.
Medidas	240 x 100 mm		

MARCADOR TIRALINEAS + AZULETE

HCLR0130



- Acc: nivel
- Marcador 30 m + Bote azul

EAN	6928073668399		10 unid.
-----	---------------	--	----------

LLANA DE GOMA
HSFR24008

COD 0592
PVP: 7,04 €



- Base de aluminio y esponja

EAN	6925582127485		10 unid.
Medidas	230 x 100 mm		
Dientes	10 mm		

LLANA DENTADA ACERO
HPTT231025

COD 0687
PVP: 4,13 €



- Medidas 230 x 100 mm
- Diente 10 x 6 mm

EAN	6941640160768		10 unid.
Medidas	230 x 100 mm		
Dientes	10 mm		

SARGENTO MONOMANUAL



- Fuerza máx. Mordaza: 170 Kg
- Medida varilla: 5 x 15 mm
- Diámetro rosca: 11 mm

MEDIDAS	EAN	REF	COD	unid.	PVP
50 x 150 mm	6928073664360	HFC020501	0468	10	5,37 €
50 x 200 mm	6928073664377	HFC020502	0469	10	5,56 €
50 x 250 mm	6928073664384	HFC020503	0470	10	5,75 €

SARGENTO MONOMANUAL

HFC020802

COD 0471

PVP: 10,03 €



- Fuerza máx. Mordaza: 270 Kg
- Medida varilla: 6 x 22 mm
- Diámetro rosca: 13,5 mm

EAN	6928073664025		10 unid.
Medidas	80 x 300 mm		

SARGENTO MONOMANUAL



- Fuerza máx. Mordaza: 450 Kg
- Medida varilla: 8 x 30 mm
- Diámetro rosca: 15,3 mm

MEDIDAS	EAN	REF	COD	unid.	PVP
120 x 300 mm	6928073664032	HFC021201	0472	6	16,56 €
120 x 400 mm	6928073662854	HFC021204	0473	6	17,71 €
120 x 500 mm	6928073662908	HFC021202	0474	6	19,40 €
120 x 600 mm	6925582117721	HFC021205	0475	6	20,03 €
120 x 800 mm	6928073662915	HFC021203	0476	6	23,81 €

SARGENTO MONOMANUAL



- Fuerza máx. mordaza: 60 kgs.
- Medida varilla: 5x18 mm

MEDIDAS	EAN	REF	COD	unid.	PVP
63x150 mm	6925582146806	HQBC01601	0615	10	5,88 €
63x300 mm	6925582146813	HQBC01602	0616	10	7,12 €
63x450 mm	6925582146820	HQBC01603	0617	10	8,42 €

SARGENTO MONOMANUAL

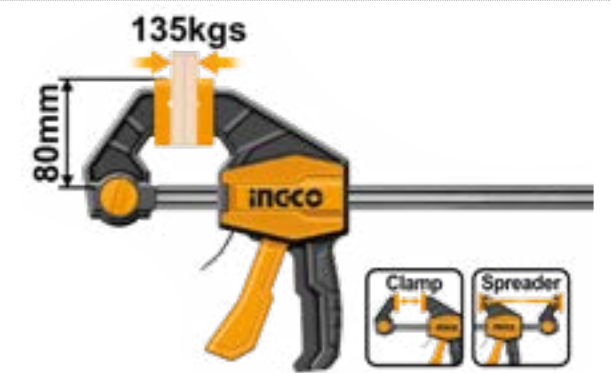

- Fuerza máx. Mordaza: 135 Kg
- Medida varilla: 6 x 18 mm

MEDIDAS	EAN	REF	COD	unid.	PVP
80 x 450 mm	6941640161680	HQBC18801	0688	12	20,88 €
80 x 600 mm	6941640166807	HQBC24802	0689	8	22,82 €
80 x 900 mm	6941640154019	HQBC36803	0690	8	27,68 €

PINZA SUJECIÓN



PVP: 1,19 €

- Fuerza máx. mordaza: 15 kgs
- Máx. apertura: 68 mm
- 150 mm

MEDIDAS	EAN	REF	COD	unid.
50 x 150 mm	6925582142440	HQSC0204	0618	10



PVP: 1,70 €

- Fuerza máx. mordaza: 12 kgs
- Máx. apertura: 50 mm
- 110 mm

MEDIDAS	EAN	REF	COD	unid.
50 x 200 mm	6925582142433	HQSC0206	0619	10

TORNILLO DE BANCO CON YUNQUE

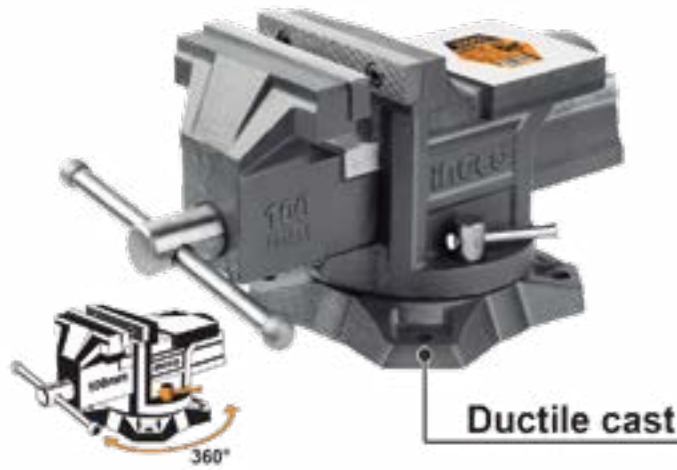

Ductile cast

- Giratorio 360°
- Medida: 200 mm
- Peso: 21 kg
- Fuerza máx. Mordaza: 2.500 kg

MEDIDAS	EAN	REF	COD	unid.	PVP
50 x 100 mm	6925582125825	HBV084	0477	1	60,50 €
50 x 150 mm	6925582127263	HBV086	0478	1	102,36 €
50 x 200 mm	6925582128901	HBV088	0479	1	174,70 €

LIMA METAL PLANA

HSFF088P



NEW

- Acero T12

EAN	REF	COD	unid.	PVP
6925582125443	HSFF088P	0791	12 unid.	4,22 €
Longitud		200 mm		

LIMA METAL TRIANGULAR

HSTF088P



NEW

- Acero T12

EAN	REF	COD	unid.	PVP
6925582125436	HSTF088P	0794	12 unid.	4,08 €
Longitud		200 mm		

TORNILLO DE BANCO

HBV082



- Giratorio 360°
- Medida base 60 mm
- Peso 1,7 kg
- Fuerza máx. Mordaza: 1000 kg

EAN	REF	COD	unid.	PVP
6925582142525	HBV082	0590	1 unid.	20,43 €

LIMA METAL MEDIA CAÑA

HSHF088P

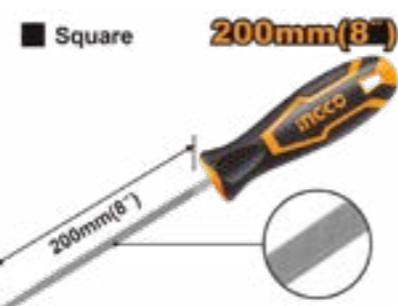

NEW

- Acero T12

EAN	REF	COD	unid.	PVP
6925582125412	HSHF088P	0792	12 unid.	4,76 €
Longitud		200 mm		

LIMA METAL REDONDA

HSRF088P

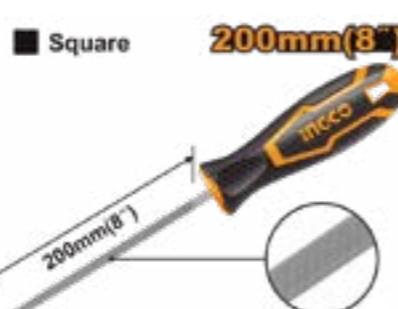

NEW

- Acero T12

EAN	REF	COD	unid.	PVP
6925582125429	HSRF088P	0793	12 unid.	3,72 €
Longitud		200 mm		

LIMA METAL CUADRADA

HSSF088



NEW

- Acero T12

EAN	REF	COD	unid.	PVP
6925582100501	HSSF088	0795	12 unid.	3,50 €
Longitud		200 mm		

JUEGO 3 LIMAS

HKTF51308

- Round steel file
- Flat steel file
- Half round steel file



- Juego de 3 limas para metales 8" 200 mm

EAN	REF	COD	unid.	PVP
6925582101249	HKTF51308	0143	10 unid.	13,36 €

JUEGO DE ESCOFINAS

HKTFW0308



- Juego de 3 escofinas para madera 8" 200 mm

EAN	REF	COD	unid.	PVP
6925582101225	HKTFW0308	0145	10 unid.	12,19 €

FORMÓN MADERA 9MM

HWC0809



NEW

- Formón Cr-v

EAN	REF	COD	unid.	PVP
6928073672679	HWC0809	0784	12 unid.	4,46 €
Ancho		14 mm		
Longitud		140 mm		

JUEGO DE LIMATONES

HKTF63



- Juego de 6 limatones 3 x 140 mm

EAN	REF	COD	unid.	PVP
6925582108514	HKTF63	0146	12 unid.	4,85 €

JUEGO 5 LIMAS

HKTF0508

- Round steel file
- Half round steel file
- Triangle steel file
- Flat steel file
- Square steel file



- Juego de 5 limas para metales 8" 200 mm

EAN	REF	COD	unid.	PVP
6925582101232	HKTF0508	0144	5 unid.	20,06 €

FORMÓN MADERA 6MM

HWC0806



NEW

- Formón Cr-v

EAN	REF	COD	unid.	PVP
6928073672662	HWC0806	0783	12 unid.	4,38 €
Ancho		12 mm		
Longitud		140 mm		

FORMÓN MADERA 12MM

HWC0812



NEW

- Formón Cr-v

EAN	REF	COD	unid.	PVP
6928073672686	HWC0812	0785	12 unid.	4,64 €
Ancho		12 mm		
Longitud		140 mm		

FORMÓN MADERA 14MM

HWC0814

COD 0786

PVP: 4,72 €



NEW

• Formón Cr-v

EAN	6928073672693		12 unid.
Ancho	14 mm		
Longitud	140 mm		

FORMÓN MADERA 19MM

HWC0819

COD 0788

PVP: 4,82 €



NEW

• Formón Cr-v

EAN	6928073672716		12 unid.
Ancho	19 mm		
Longitud	140 mm		

FORMÓN MADERA 25MM

HWC0825

COD 0790

PVP: 5,16 €



NEW

• Formón Cr-v

EAN	6928073672730		12 unid.
Ancho	25 mm		
Longitud	140 mm		

FORMÓN MADERA 16MM

HWC0816

COD 0787

PVP: 4,78 €



NEW

• Formón Cr-v

EAN	6928073672709		12 unid.
Ancho	16 mm		
Longitud	140 mm		

FORMÓN MADERA 22MM

HWC0822

COD 0789

PVP: 4,96 €



NEW

• Formón Cr-v

EAN	6928073672723		12 unid.
Ancho	22 mm		
Longitud	140 mm		

JUEGO DE FORMONES

HKTWC0401

COD 0115

PVP: 16,80 €



• Formones 6 mm / 12 mm / 19 mm / 25 mm

EAN	6928073711682		4 unid.
-----	---------------	--	---------

DESTORNILLADOR DE PUNTA PLANA 6 X 38

HS686038

COD 0237

PVP: 1,48 €



EAN	6941640126825		12 unid.
Ancho	6,0 mm		
Longitud	38 mm		

DESTORNILLADOR DE PUNTA PLANA 5 X 75

HS685075

COD 0239

PVP: 1,39 €



EAN	6941640126733		12 unid.
Ancho	5,0 mm		
Longitud	75 mm		

DESTORNILLADOR DE PUNTA PLANA 6 X 125

HS686125

COD 0240

PVP: 1,90 €



EAN	6941640126771		12 unid.
Ancho	6,0 mm		
Longitud	125 mm		

JUEGO DESTORNILLADORES 6 PCS

HKSD0628

COD 0088

PVP: 8,90 €



• Destornillador punta plana 5,5 x 75 / 5,5 x 100 / 6,5 x 150 mm
• Destornillador punta PHILLIPS 1 x 75 / 1 x 100 / 2 x 150 mm

EAN	6928073680261		5 unid.
-----	---------------	--	---------

DESTORNILLADOR DE PUNTA PLANA 4 X 100

HS684100

COD 0238

PVP: 1,25 €



EAN	6941640126702		12 unid.
Ancho	4,0 mm		
Longitud	100 mm		

DESTORNILLADOR DE PUNTA PLANA 5 X 100

HS685100

COD 0393

PVP: 1,43 €



EAN	6941640126757		12 unid.
Ancho	5 mm		
Longitud	100 mm		

DESTORNILLADOR DE PUNTA PLANA 8 X 150

HS688150

COD 0394

PVP: 2,77 €



EAN	6941640168764		12 unid.
Ancho	8,0 mm		
Longitud	150 mm		

JUEGO DESTORNILLADORES 8 PCS

HKSD0828

COD 0090

PVP: 13,12 €



• Destornillador punta plana 3 x 75 / 5 x 100 / 6 x 150 / 6 x 38 mm
• Destornillador punta PHILLIPS 0 x 75 / 1 x 75 / 2 x 125 / 2 x 38 mm

EAN	6925582104462		5 unid.
-----	---------------	--	---------

DESTORNILLADOR PHILLIPS PH2 X 38 COD 0241

HS68PH2038



• PH2

EAN	6941640126696	12 unid.
Diámetro	6,0 mm	
Longitud	38 mm	

DESTORNILLADOR PHILLIPS PH1 X 75 COD 0243

HS68PH1075



• PH1

EAN	6941640126740	12 unid.
Diámetro	5,0 mm	
Longitud	75 mm	

DESTORNILLADOR PHILLIPS PH3 X 150 COD 0245

HS68PH3150



EAN	6941640165794	12 unid.
Diámetro	8,0 mm	
Longitud	150 mm	

JUEGO DESTORNILLADORES 10 PCS COD 0091

HKSD1028



- Destornillador punta plana 3 x 75 / 4 x 100 / 5,5 x 125 / 6,5 x 150 / 8 x 200 / 6 x 38 mm
- Destornillador punta PHILLIPS 0 x 60 / 1 x 80 / 2 x 100 / 3 x 150 mm

EAN	6925582104486	5 unid.
-----	---------------	---------

DESTORNILLADOR PHILLIPS PH0 X 75 COD 0242

HS68PH0075



• PH0

EAN	6941640126726	12 unid.
Diámetro	3,0 mm	
Longitud	75 mm	

DESTORNILLADOR PHILLIPS PH2 X 125 COD 0244

HS68PH2125



• PH2

EAN	6941640126764	12 unid.
Diámetro	6,0 mm	
Longitud	125 mm	

DESTORNILLADOR POZIDRIV



• Punta pozidriv

MODELO	EAN	REF	COD	unid.	P.V.C.
PZ1 x 100	6941640144911	HS68PZ1100	0413	12	1,44 €
PZ2 x 150	6941640141934	HS68PZ2150	0246	12	1,97 €

JUEGO DESTORNILLADORES 18 PCS COD 0092

HKSD1828



- Set de precisión
- Destornillador punta plana 5,5 x 75 / 6,5 x 100 / 8 x 150 / 6 x 38 mm
- Destornillador punta PHILLIPS 1 x 75 / 2 x 100 / 3 x 150 / 2 x 38 mm

EAN	6925582104479	5 unid.
-----	---------------	---------

DESTORNILLADOR TORX T-6 COD 0796

HSDT06075



• TX-6

EAN	6976051781066	12 unid.
Ancho	6 mm	
Longitud	75 mm	

DESTORNILLADOR TORX T-8 COD 0798

HSDT08075



• TX-8

EAN	6976051781080	12 unid.
Ancho	8 mm	
Longitud	75 mm	

DESTORNILLADOR TORX T-10 COD 0800

HSDT10075



• TX-10

EAN	6976051781103	12 unid.
Ancho	10 mm	
Longitud	75 mm	

DESTORNILLADOR TORX T-15 COD 0802

HSDT15100



• TX-15

EAN	6976051781127	12 unid.
Ancho	15 mm	
Longitud	100 mm	

DESTORNILLADOR TORX T-25 COD 0804

HSDT25150



• TX-25

EAN	6976051781141	12 unid.
Ancho	25 mm	
Longitud	150 mm	

DESTORNILLADOR TORX T-30 COD 0806

HSDT30150



• TX-30

EAN	6976051781165	12 unid.
Ancho	30 mm	
Longitud	150 mm	

DESTORNILLADOR TORX T-7 COD 0797

HSDT07075



• TX-7

EAN	6976051781073	12 unid.
Ancho	7 mm	
Longitud	75 mm	

DESTORNILLADOR TORX T-9 COD 0799

HSDT09075



• TX-9

EAN	6976051781097	12 unid.
Ancho	9 mm	
Longitud	75 mm	

DESTORNILLADOR TORX T-10 COD 0801

HSDT10100



• TX-10

EAN	6976051781110	12 unid.
Ancho	10 mm	
Longitud	100 mm	

DESTORNILLADOR TORX T-20 COD 0803

HSDT20150



• TX-40

EAN	6976051781134	12 unid.
Ancho	20 mm	
Longitud	150 mm	

DESTORNILLADOR TORX T-27 COD 0805

HSDT27150



• TX-27

EAN	6976051781158	12 unid.
Ancho	27 mm	
Longitud	150 mm	

DESTORNILLADOR TORX T-40 COD 0807

HSDT40150



• TX-40

EAN	6928073681172	12 unid.
Ancho	40 mm	
Longitud	150 mm	

DESTORNILLADOR ELECTRICISTA PLANO 3x75 COD 0395

HISD813075 PVP: 1,69 €



- Aislado 1000 V
- Certificado VDE

EAN	6928073712146	12 unid.
Ancho	4 mm	
Longitud	75 mm	

DESTORNILLADOR ELECTRICISTA PLANO 5x125 COD 0397

HISD815125 PVP: 2,48 €



- Aislado 1000 V
- Certificado VDE

EAN	6928073680735	12 unid.
Ancho	5 mm	
Longitud	125 mm	

DESTORNILLADOR ELECTRICISTA PHILLIPS PH0x60 COD 0399

HISD81PH060 PVP: 1,65 €



- Aislado 1000 V
- Certificado VDE

EAN	6928073680759	12 unid.
Ancho	PH0	
Longitud	60 mm	

DESTORNILLADOR ELECTRICISTA PHILLIPS PH2x100 COD 0401

HISD81PH2100 PVP: 2,74 €



- Aislado 1000 V
- Certificado VDE

EAN	6928073680773	12 unid.
Ancho	PH2	
Longitud	100 mm	

DESTORNILLADOR ELECTRICISTA PLANO 4x100 COD 0396

HISD814100 PVP: 2,28 €



- Aislado 1000 V
- Certificado VDE

EAN	6928073680728	12 unid.
Ancho	4 mm	
Longitud	100 mm	

DESTORNILLADOR ELECTRICISTA PLANO 6x150 COD 0398

HISD816150 PVP: 3,08 €



- Aislado 1000 V
- Certificado VDE

EAN	6928073680742	12 unid.
Ancho	6 mm	
Longitud	150 mm	

DESTORNILLADOR ELECTRICISTA PHILLIPS PH1x80 COD 0400

HISD81PH180 PVP: 2,15 €



- Aislado 1000 V
- Certificado VDE

EAN	6928073680766	12 unid.
Ancho	PH1	
Longitud	80 mm	

JUEGO DE 6 DESTORNILLADORES ELECTRICISTA COD 0402

HKISD0608 PVP: 16,78 €



- Aislado 1000 V
- Certificado VDE
- Destornillador punta plana 3 x 75 / 4 x 100 / 6,5 x 150 mm
- Destornillador punta PHILLIPS 0 x 60 / 1 x 80 / 2 x 150 mm

EAN	6928073680797	6 unid.
-----	---------------	---------

DESTORNILLADOR ELECTRICISTA POZIDRIV 1x80 COD 0885

HISD81PZ180 PVP: 2,60 €



- Aislado 1000 V
- Certificado VDE

EAN	6925582143065	12 unid.
Ancho	1 mm	
Longitud	80 mm	

JUEGO DESTORNILLADORES 2 PCS COD 0087

HKSD0248 PVP: 3,41 €



- Destornillador punta plana 6,5 x 100 mm
- Destornillador punta PHILLIPS 2 x 100 mm

EAN	6925582111910	10 unid.
-----	---------------	----------

DESTORNILLADOR 6 EN 1 COD 0094

AKISD0608 PVP: 4,14 €

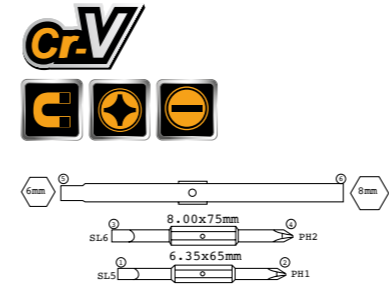

- Mango con punta intercambiable
- Puntas incluidas

EAN	6925582117295	18 unid.
-----	---------------	----------

JUEGO DESTORNILLADORES PRECISIÓN COD 0096

HKSD0718 PVP: 7,39 €



- 7 destornilladores

EAN	6925582104189	6 unid.
-----	---------------	---------

DESTORNILLADOR ELECTRICISTA POZIDRIV 2x100 COD 0886

HISD81PZ2100 PVP: 2,60 €



- Aislado 1000 V
- Certificado VDE

EAN	6928073680780	12 unid.
Ancho	2 mm	
Longitud	100 mm	

DESTORNILLADOR 2 EN 1 REVERSIBLE COD 0093

AKISD0201 PVP: 2,63 €



- Destornillador punta plana 6,5 x 160 mm
- Destornillador punta PHILLIPS PH2 x 160 mm

EAN	6928073683729	12 unid.
-----	---------------	----------

JUEGO DESTORNILLADORES 9 PCS COD 0095

AKISD0901 PVP: 7,80 €



- Mango intercambiable

EAN	6928073673485	12 unid.
-----	---------------	----------

DESTORNILLADOR 13 EN 1 COD 0097

AKISD1208 PVP: 6,09 €



- Destornillador con puntas intercambiables
- Puntas incluidas

EAN	6925581122374	12 unid.
-----	---------------	----------

DESTORNILLADOR MANGO T

COD 0098

HKSD0188

PVP: 7,61 €



- SL3,SL4,SL5,SL6
- PH0,PH1,PH2,PH3
- PZ1,PZ2
- 5mm,6mm,7mm,8mm,9mm,10mm
- T15,T20
- H4,H5,H6

1Pcs 4-6mm adaptor

- Puntas y vasos intercambiables



EAN 6925582117059 6 unid.

DESTORNILLADOR 24 PCS

COD 0099

HKSD0248

PVP: 9,22 €

- SL3,SL4,SL5,SL6,SL7
- PH1,PH2,PH2,PH3
- PZ1,PZ2
- T10,T15,T20,T25

7Pcs 1/4" Power sleeve:
5mm,6mm,7mm,8mm,
9mm,10mm,11mm



- Mango destornillador + 24 puntas



EAN 6925582117332 6 unid.

JUEGO DESTORNILLADOR 26 PCS

COD 0102

HKSD0268

PVP: 17,86 €



- Mango destornillador + 26 accesorios

EAN 6925582104134 6 unid.

BLISTER 2 PORTAPUNTAS

COD 0298

ABH10601

PVP: 2,70 €



2PCS/SET
60mm (2-3/8")

- 2 Piezas de 60 mm



EAN 6928073669075 25 unid.

JUEGO DESTORNILLADOR 33 PCS

COD 0101

HKSD0338

PVP: 19,88 €



- SL3,SL4,SL5,SL6,SL6
- PH0,PH1,PH2,PH2,PH3
- PZ1,PZ2
- T10,T15,T20,T25,T30
- H3,H4,H5
- 1/4" socket:
4,5,6,7,8,9,10,11,12mm

- Mango destornillador + 33 accesorios



EAN 6925582117516 6 unid.

PORTAPUNTAS + 9 PUNTAS

COD 0299

AKSD0071

PVP: 3,95 €



- 9 Puntas
- PH1 / PH2 / PH3 / SL4.0 / SL5.5 / SL6.5 / PZ1 / PZ
- Puntas imantadas
- Material: acero CR-V
- Portapuntas con anclaje

EAN 6928073675229 25 unid.

JUEGO DE LLAVES ALLEN

COD 0163

HHK11091

PVP: 5,43 €



- 1,5 - 10 mm

EAN 6928073675144 6 unid.
Longitud 180 mm

JUEGO DE LLAVES ALLEN BOLA

COD 0165

HHK12091

PVP: 7,18 €



- 1,5 - 10 mm

EAN 6928073675168 6 unid.
Longitud 180 mm

SET 29 PUNTAS ATORNILLAR

COD 0480

AKSD08301

PVP: 8,53 €



- Caja plástico
- 1 portapuntas
- Tamaño: PZO / PZ1 / PZ2 / PZ3 / PH0 / PH1 / PH2 / PH2 / PH3 / PH4 / SL3 / SL4 / SL5 / SL6 / T10 / T15 / T20 / T25 / T27 / T30 / T40 / H3 / H4 / H5 / H6 / S1 / S2 / S3

EAN 6925582130645 10 unid.

JUEGO DE LLAVES ALLEN EXTRA LARGA

COD 0164

HHK11092

PVP: 7,25 €



- 1,5 - 10 mm

EAN 6928073675151 6 unid.
Longitud 230 mm

JUEGO DE LLAVES ALLEN BOLA EXTRA LARGA

COD 0166

HHK12092

PVP: 8,62 €



- 1,5 - 10 mm

EAN 6928073675175 6 unid.
Longitud 230 mm

JUEGO DE LLAVES TORX

HHK13091



• T10 -T50

EAN	6925582100358		6 unid.
Longitud	17,5 mm		

COD 0167

PVP: 6,86 €

JUEGO DE LLAVES TORX EXTRA LARGAS

HHK13092



• T10 -T50

EAN	6928073675182		6 unid.
Longitud	230 mm		

COD 0168

PVP: 8,14 €

JUEGO DE LLAVES ALLEN

HHK14081



• 2 - 8 mm

EAN	6928073675199		12 unid.
-----	---------------	--	----------

COD 0169

PVP: 5,53 €

JUEGO DE LLAVES ALLEN BOLA

HHK14082



• 2 - 8 mm

EAN	6925582101959		12 unid.
-----	---------------	--	----------

COD 0170

PVP: 6,04 €

JUEGO DE LLAVES TORX

HHK14083



• T10 -T40

EAN	6925582100020		12 unid.
-----	---------------	--	----------

COD 0171

PVP: 6,04 €

JUEGO DE LLAVES ALLEN MANGO T

HHKT8081



• 8 Piezas
• 2 - 10 mm

EAN	6925582122763		10 unid.
-----	---------------	--	----------

COD 0172

PVP: 22,82 €

JUEGO DE LLAVES ALLEN BOLA MANGO T

HHKT80828



• 8 Piezas
• 2 - 10 mm

EAN	69411640156730		10 unid.
-----	----------------	--	----------

COD 0173

PVP: 23,39 €

JUEGO DE LLAVES TORX MANGO T

HHKT80838



• 8 Piezas
• T10 -T50

EAN	6941640166968		10 unid.
-----	---------------	--	----------

COD 0174

PVP: 23,51 €

LLAVE CARRACA 1/4"

HRTH0814



EAN	6925582114799		1 unid.
Tamaño	1/4" 45T		
Longitud	158 mm		
Material	CR-V + CR-MO		

COD 0252

PVP: 7,68 €

LLAVE CARRACA 3/8"

HRTH0838



EAN	6925582114805		1 unid.
Tamaño	3/8" 45T		
Longitud	205 mm		
Material	CR-V + CR-MO		

COD 0253

PVP: 11,10 €

LLAVE CARRACA 1/2"

45T HRTH0812



EAN	6925582114492		1 unid.
Tamaño	1/2" 45T		
Longitud	260 mm		
Material	CR-V + CR-MO		

COD 0254

PVP: 15,26 €

LLAVE CARRACA 1/2"

72T HRTH8412



EAN	6925582117226		6 unid.
Tamaño	1/2" 72T		
Largo	260 mm		
Material	CR-V + Cr-Mo		

COD 0280

PVP: 16,12 €

LLAVE CARRACA COD 0691
 HIRTH081438 PVP: 10,18 €



- Tamaño 1/4" - 3/8" 72T
- Largo 140 mm
- Material CR-V + CR-MO

EAN	6941640169846		12 unid.
Tamaño	1/2" 72T		
Largo	260 mm		
Material	CR-V + Cr-Mo		

LLAVE AJUSTABLE 2 EN 1 COD 0810 - 0811
 HADWS088 - HADWG0810 PVP: 7,28 €
PVP: 16,56 €



EAN	6941640174994		6 unid.
-----	---------------	--	---------

LLAVE AJUSTABLE



TAMAÑO	EAN	REF	COD	unid.	PVP
6"	6925582103724	HADW131068	0079	6	6,39 €
8"	6925582103731	HADW131088	0080	6	8,47 €
10"	6925582103700	HADW131108	0081	6	11,91 €
12"	6925582103717	HADW131128	0082	4	16,33 €

JUEGO DE LLAVES DE AJUSTE RÁPIDO COD 0104
 HBWS110808 PVP: 11,07 €



- 9 - 14 mm / 15 - 22 mm / 23 - 32 mm

EAN	6925582113556		5 unid.
-----	---------------	--	---------

LLAVE AJUSTABLE



• Material Cr-v

MEDIDA	EAN	REF	COD	Unid.	PVP
6	6925582116632	HCSPAR061	0824	10	3,36 €
8	6925582111927	HCSPAR081	0825	10	3,36 €
10	6925582111934	HCSPAR101	0826	10	4,00 €
11	6925582111941	HCSPAR111	0827	10	4,13 €
12	6925582111958	HCSPAR121	0828	10	4,45 €
13	6925582111965	HCSPAR131	0829	10	4,78 €
14	6925582111972	HCSPAR141	0830	10	5,09 €
15	6925582111989	HCSPAR151	0831	10	5,35 €
16	6925582111996	HCSPAR161	0831	10	5,61 €
17	6925582112009	HCSPAR171	0832	10	5,76 €
19	6925582112016	HCSPAR191	0833	10	6,50 €
21	6925582112023	HCSPAR211	0834	10	8,42 €
24	6925582112030	HCSPAR241	0835	10	11,04 €
27	6925582112047	HCSPAR271	0836	10	13,24 €

JUEGO DE LLAVES PLANAS 8 PCS COD 0154
 HKSPA2088 PVP: 15,73 €



- 6 - 22 mm

EAN	6925582118162		5 unid.
-----	---------------	--	---------

JUEGO DE LLAVES COMBINADAS 8 PCS COD 0153
 HKSPA1088-1 PVP: 15,40 €



- 6 - 19 mm

JUEGO DE LLAVES ACODADAS 8 PCS COD 0155
 HKSPA3088 PVP: 20,55 €



- 6 - 22 mm
- 8 - 19 mm

EAN	6925582118179		5 unid.
-----	---------------	--	---------

JUEGO DE LLAVES CARRACA 8 PCS COD 0156
 HKSPAR1082 PVP: 40,91 €



EAN	6925582121230		5 unid.
-----	---------------	--	---------

JUEGO LLAVES CARRACA ARTICULADA COD 0624
 HKSPAR1083 PVP: 48,12 €



- 8-19 mm

LLAVE PLANA



• Material Cr-v

MEDIDA	EAN	REF	COD	Unid.	PVP
6x7	6928073677391	HDSPA06071	0812	10	1,02 €
8x9	6928073677407	HDSPA08091	0813	10	1,12 €
10x11	6928073677360	HDSPA10111	0814	10	1,24 €
12x13	6928073677377	HDSPA12131	0815	10	1,30 €
14x15	6928073677384	HDSPA14151	0816	10	1,66 €
16x17	6928073677339	HDSPA16171	0817	10	1,90 €
18x19	6928073677346	HDSPA18191	0818	10	2,18 €
20x22	6928073677353	HDSPA20221	0819	10	2,58 €
21x23	6928073677308	HDSPA21231	0820	10	3,12 €
24x27	6928073677315	HDSPA24271	0821	10	4,30 €
25x28	6928073677322	HDSPA24271	0822	10	5,30 €
30x32	6928073677292	HDSPA30321	0823	10	5,98 €

LLAVE ACODADA



- Material: Cr-v
- Cromado, acabado mate

MEDIDA	LONGITUD	EAN	REF	COD	Unid.	PVP
6x7mm	118 mm	6928073677278	HOSPA06071	0837	10	1,12 €
8x9mm	137 mm	6928073677285	HOSPA08091	0838	10	1,30 €
10x11mm	161 mm	6928073677247	HOSPA10111	0839	10	1,42 €
12x13mm	186 mm	6928073677254	HOSPA12131	0840	10	1,64 €
14x15mm	213 mm	6928073677261	HOSPA14151	0841	10	2,12 €
16x17mm	219 mm	6928073677216	HOSPA16171	0842	10	2,48 €
18x19mm	251 mm	6928073677223	HOSPA18191	0843	10	2,58 €
20x22mm	270 mm	6928073677230	HOSPA20221	0844	10	3,38 €
21x23mm	296 mm	6928073677186	HOSPA21231	0845	10	4,14 €
24x27mm	342 mm	6928073677193	HOSPA24271	0846	10	5,56 €
25x28mm	342 mm	6928073677209	HOSPA25281	0847	10	5,60 €
30x32mm	401 mm	6928073677179	HOSPA30321	0848	10	7,26 €

VASO 1/2



MEDIDA	EAN	REF	COD	Unid.	P.V.P
8	6928073714232	HHAST12081	0849	10	1,48 €
9	6928073714249	HHAST12091	0850	10	1,48 €
10	6928073714256	HHAST12101	0851	10	1,48 €
11	6928073714263	HHAST12111	0852	10	1,48 €
12	6928073714270	HHAST12121	0853	10	1,48 €
13	6928073714287	HHAST12131	0854	10	1,48 €
14	6928073714290	HHAST12141	0855	10	1,48 €
15	6928073714300	HHAST12151	0856	10	1,48 €
16	6928073714317	HHAST12161	0857	10	1,48 €
17	6925582109139	HHAST12171	0858	10	1,60 €
18	6928073714331	HHAST12181	0859	10	1,78 €
19	6925582109146	HHAST12191	0860	10	1,78 €
20	6928073714355	HHAST12201	0861	10	1,84 €
21	6928073714362	HHAST12211	0862	10	1,84 €
22	6928073714379	HHAST12221	0863	10	2,12 €
23	6925582103199	HHAST12231	0864	10	2,38 €
24	6925582109153	HHAST12241	0865	10	2,38 €
25	6925582103205	HHAST12251	0866	10	2,58 €
26	6925582103212	HHAST12261	0867	10	2,86 €
27	6928073714393	HHAST12271	0868	10	3,06 €
28	6925582103229	HHAST12281	0869	10	3,76 €
29	6925582103236	HHAST12291	0870	10	3,76 €
30	6928073714409	HHAST12301	0871	10	3,98 €
32	6928073714416	HHAST12321	0872	10	4,36 €

JUEGO VASOS IMPACTO

HKISSD12101

COD 0608

PVP: 22,74 €



- Inserción 1/2"
- Largo: 38 mm
- 10-12-13-14-15-17-19-21-22-24 mm

EAN 6925582132601 6 unid.

JUEGO VASOS IMPACTO LARGO

HKISSD12102L

COD 0609

PVP: 38,46 €



- Inserción 1/2"
- Largo: 78mm
- 10-12-13-14-15-17-19-21-22-24 mm

EAN 6925582144628 6 unid.

RÓTULA 1/2"

HHUJ1121

COD 0873

PVP: 4,90 €



- Material: Cr-v
- "1/2"

EAN 6925582104868 5 unid.

ALARGADERA 1/2" 125MM

HEB12051

COD 0874

PVP: 3,68 €



- Material: Cr-v
- "1/2" Longitud: 125mm"

EAN 6925582104875 5 unid.

MANGO ARTICULADO 1/2" 375MM

HFXH012151

COD 0876

PVP: 12,14 €



- Material: Cr-v
- "1/2" Longitud: 375mm"

EAN 6925582144000 5 unid.

JUEGO DE VASOS 12 PCS

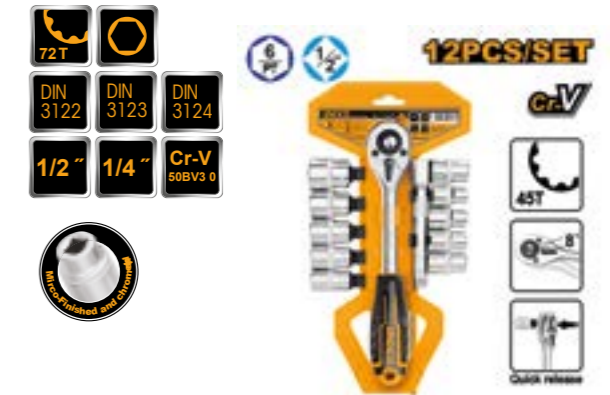

- Cr-V 72T
- Cr-V 45T

MEDIDA	EAN	REF	COD	Unid.	PVP
5 - 14 mm	6925582137019	HKTS14122	0481	5	16,07 €
10 - 24 mm	6925582109160	HKTS12122	0157	5	32,63 €

ALARGADERA 1/2" 250MM

HEB12101

COD 0875

PVP: 6,28 €



- Material: Cr-v
- "1/2" Longitud: 250mm"

EAN 6925582104882 5 unid.

MANGO CORREDERO 1/2" 250MM

HSTB12101

COD 0877

PVP: 5,44 €

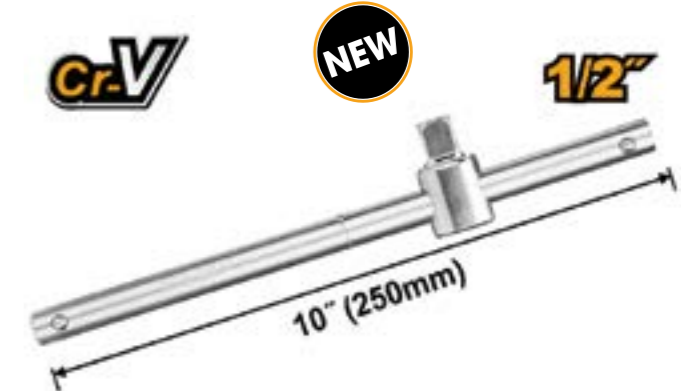

- Material: Cr-v
- 1/2" Longitud: 250mm

EAN 6925582143928 5 unid.

JUEGO DE LLAVES COMBINADAS 12 PCS COD 0158

HKSPA1143

PVP: 52,02 €



• 6 - 32 mm

EAN 6928073712870 1 unid.

JUEGO DE LLAVES PLANAS 12 PCS COD 0159

HKSPA2142

PVP: 42,52 €



• 6 - 32 mm

EAN 6928073671467 1 unid.

JUEGO DE LLAVES COMBINADAS 12 PCS COD 0162

HKSPA1142

PVP: 31,54 €



• 6 - 24 mm

EAN 6928073671450 1 unid.

JUEGO DE LLAVES ACODADAS 12 PCS COD 0160

HKSPA3142

PVP: 56,88 €



• 6 - 32 mm

EAN 6928073671474 1 unid.

JUEGO DE LLAVES CARRACA 6 PCS COD 0161

HKSPAR1061

PVP: 79,30 €



• 19 - 32 mm

EAN 6925582101355 1 unid.

LLAVE STILSON



PULG.	APER.	EAN	REF	COD	Unid.	PVP
8"	27mm	6925582115673	HPW0808	0069	6	7,02 €
10"	34mm	6925582115680	HPW0810	0070	6	8,96 €
12"	42mm	6925582114232	HPW0812	0071	3	10,99 €
14"	50mm	6925582115024	HPW0814	0072	3	13,08 €
18"	60mm	6925582115031	HPW0818	0073	2	19,56 €
24"	76mm	6925582116533	HPW0824	0074	4	28,22 €
36"	85mm	6925582116540	HPW0836	0075	3	51,26 €
48"	110mm	6925582116557	HPW0848	0076	2	72,81 €

LLAVE STILSON AUTOMÁTICA



PULGADAS	EAN	REF	COD	Unid.	PVP
10"	6925582112702	HPW1410	0077	6	16,71 €
14"	6925582112696	HPW1414	0078	4	27,06 €

CORTATUBOS PVC

COD 0084

HPC0543

PVP: 7,47 €



Automatic open

• Apertura automática

EAN	Cortatubos	Longitud	Unid.	PVP
6925582104820	3 - 42 mm	193 mm	6 unid.	

CORTATUBOS COBRE

COD 0086

HPC0232

PVP: 8,29 €



• Cortatubos de cobre y aluminio de 3 - 32 mm

EAN	Unid.	PVP
6928073711071	12 unid.	

CORTAVARILLAS



PULG.	CORTE	EAN	REF	COD	Unid.	PVP
14"	7mm	6925582116779	HBC0814	0403	1	15,88 €
18"	8mm	6925582116786	HBC0818	0404	1	21,02 €
24"	10mm	6925582117097	HBC0824	0405	1	30,44 €
30"	13mm	6925582117103	HBC0830	0406	1	42,72 €
36"	16mm	6925582117349	HBC0836	0407	1	52,61 €
42"	19mm	6925582117356	HBC0842	0408	1	75,18 €
48"	20mm	6925582117615	HBC0848	0409	1	84,16 €

CORTATUBOS PVC

COD 0085

HPC0442

PVP: 12,28 €



Automatic open

• Apertura automática

EAN	Cortatubos	Longitud	Unid.	PVP
6928073669501	3 - 42 mm	225 mm	4 unid.	

TIJERA CHAPA IZQUIERDA

COD 0140

HTSN0110L

PVP: 8,35 €



• Tijera chapa izquierda 250 mm

EAN	Unid.	PVP
6928073664452	5 unid.	

TIJERA CHAPA DERECHA

COD 0142

HTSN0110R

PVP: 8,36 €



• Tijera chapa derecha 250 mm

EAN	Unid.	PVP
6928073664438	5 unid.	

TIJERA CHAPA COD 0141
HTSN0110S PVP: 8,43 €



• Tijera chapa centrada 250 mm
EAN 6928073664445 5 unid.

ARCO SIERRA METÁLICO COD 0116
HHF3008 PVP: 10,60 €



• Arco sierra metálico ajustable
EAN 6928073673348 6 unid.

SIERRA CON GUÍA COD 0118
HMBS3008 PVP: 11,76 €



• Sierra para cortar a inglete 300 mm
EAN 6925582106954 6 unid.

TIJERA CHAPA RECTA LARGA COD 0482
HTSN0112S PVP: 10,70 €



• Tijera chapa centrada 300 mm.
EAN 6928073672846 5 unid.

ARCO DE SIERRA METÁLICO COD 0117
HHF3028 PVP: 5,60 €



• Arco sierra metálico.
EAN 6925582114645 6 unid.

SIERRA COD 0483
HMBSB3008 PVP: 7,28 €



• Hoja de tratamiento térmico.
• Sierra 300 mm
EAN 6925582122831 6 unid.

SIERRA COMPÁS COD 0119
HCS3008 PVP: 6,85 €



• Sierra madera 12" 300 mm
EAN 6925582123944 12 unid.

CUTTER MANUAL COD 0633
HKNS16001 PVP: 0,69 €



EAN 6941640156167 12 unid.
Cuchilla 18 x 100 mm
Longitud 152 mm

CUTTER MANUAL COD 0121
HKNS16518 PVP: 1,82 €



EAN 6925582126594 12 unid.
Cuchilla 18 x 100 mm
Longitud 158 mm

SIERRA MURO COD 0120
HWBSW68 PVP: 6,52 €



• Sierra para pladur
EAN 6925582123593 6 unid.

CUTTER MANUAL COD 0621
HKNS16218 PVP: 1,48 €



EAN 6925582153507 12 unid.
Cuchilla 18 x 100 mm
Longitud 158 mm

CUTTER MANUAL COD 0122
HKNS16618 PVP: 1,82 €



• Fijación con ruleta
EAN 6925582128154 12 unid.
Cuchilla 18 x 100 mm
Longitud 158 mm

CUTTER MANUAL COD 0123
HKNS16538 PVP: 3,46 €



• Contiene 3 cuchillas

EAN	6925582127225		12 unid.
Cuchilla	18 x 100 mm		
Longitud	169 mm		

CUTTER MANGO METALICO COD 0125
HKNS1807 PVP: 2,92 €



• Mango metálico

EAN	6928073673546		12 unid.
Cuchilla	18 x 100 mm		
Longitud	158 mm		

CUTTER MANUAL COD 0622
HKNS1808 PVP: 7,77 €



• Estructura aluminio
• Fijación con ruleta
• Contiene 6 cuchillas

• Cuchilla 18 x 100
• Longitud 158 mm

EAN	6925582122619		6 unid.
Cuchilla	61 x 19 mm		

CUTTER MANUAL COD 0124
HKNS1806 PVP: 0,71 €



• Caja de 48 unidades

EAN	6928073672877		48 unid.
Cuchilla	9 x 80 mm		
Longitud	129 mm		

CUTTER MANUAL 3 HOJAS COD 0692
HKNS28035 PVP: 2,35 €



• Contiene 3 cuchillas

EAN	6941640156464		12 unid.
Cuchilla	18 x 100 mm		
Longitud	162 mm		

CUTTER MANUAL COD 0127
HUK6128 PVP: 5,93 €



• Incluye 6 cuchillas

EAN	6925582136944		6 unid.
Cuchilla	61 x 19 mm		

CUTTER 61x19 ALUMINIO COD 0128
HUK6138 PVP: 6,70 €



• Cuchilla 61x19 mm
• Incluye 6 cuchillas
• Aluminio

EAN	6925582138318		12 unid.
-----	---------------	--	----------

CUCHILLO RECTO COD 0613
HPK82101 PVP: 4,32 €



• Cuchilla acero inoxidable
• Longitud 200 mm

EAN	6925582148886		6 unid.
Cuchilla	61 x 19 mm		

CUCHILLO CURVO COD 0614
HPK82001 PVP: 4,39 €



• Cuchilla acero inoxidable
• Longitud 200 mm

EAN	6925582148947		6 unid.
Cuchilla	61 x 19 mm		

CUCHILLA CUTTER COD 0132
HKNSB112 PVP: 0,75 €



• Pack 10 unidades

EAN	6941640166333		30 unid.
Cuchilla cutter	18 x 100 mm		

CUCHILLA CUTTER COD 0693
HKNSB0901 PVP: 0,63 €



• Pack 10 unidades

EAN	6941640169235		20 unid.
Cuchilla cutter	9 x 80 mm		

CUCHILLA CUTTER COD 0134
HUKB611 PVP: 0,82 €



• Pack de 10 unidades

EAN	6925582102796		30 unid.
Cuchilla cutter	19 x 61 mm		

ALICATE MULTIUSOS COD 0137
HFMFT0115 PVP: 17,86 €



EAN	6925582101140		6 unid.
Funciones			15

NAVAJA MULTIUSOS COD 0136
HMFK8158 PVP: 7,89 €



EAN	6925582122404		12 unid.
Funciones			15

RASQUETA CRISTAL COD 0694
HGS31751 PVP: 1,58 €



- Cuchilla 61 x 19mm
- Medida 175mm

EAN	6941640150356		10 unid.
-----	---------------	--	----------

CORTADOR DE CRISTALES COD 0138
HGCT02 PVP: 2,39 €



- Cortacristales 6 cuchillas

EAN	6925582105407		6 unid.
Longitud			130 mm

RASCADOR METÁLICO CON MANGO COD 0135
HGS3008 PVP: 5,84 €



- Rascador metálico
- Utiliza cuchilla cutter 18 x 100 mm

EAN	6925582121773		5 unid.
-----	---------------	--	---------

CORTADOR DE CRISTALES COD 0139
HGCT03 PVP: 3,78 €



- Cortacristales

EAN	6928073671641		6 unid.
Longitud			178 mm

ESPÁTULA COD 0314



- Acero inoxidable
- Tratamiento térmico

LONGITUD	EAN	REF	COD	unid.	PVP
40 mm	6925582143874	HPUT08040	0623	12	2,21 €
60 mm	6925582106121	HPUT08060	0309	12	2,28 €
80 mm	6925582106138	HPUT08080	0310	12	2,54 €
100 mm	6925582106145	HPUT08100	0311	12	2,76 €
125 mm	6928073683880	HPUT08125	0312	12	3,50 €
150 mm	6925582106152	HPUT08150	0313	12	3,95 €

ESPÁTULA COD 0315
HPUT38250 PVP: 4,81 €



- Escayolista
- Placa de soporte de aluminio
- Mango diseño INGCO

EAN	6941640136213		10 unid.
Tamaño			10"/250 mm
Espesor cuchilla			0.5 mm

CEPILLO DE MANO COD 0484
HWB02250 PVP: 2,47 €



- Mango de plástico
- Medidas: 250 mm
- Alambre ondulado

EAN	6928073669105		15 unid.
-----	---------------	--	----------

ESPÁTULA COD 0314



- Escayolista
- Placa de soporte de aluminio
- Mango diseño INGCO

EAN	6941640149008		10 unid.
Medida			8"/200 mm
Espesor cuchilla			0.5 mm

ESPÁTULA MULTIFUNCIÓN COD 0316
HPUT08060M PVP: 3,18 €

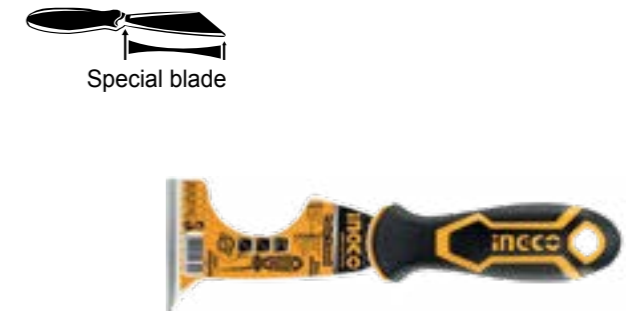

- Acero Inoxidable
- Tratamiento térmico

EAN	6925582127492		12 unid.
Tamaño			60 mm
Espesor			1,5 mm

VENTOSA SIMPLE/ DOBLE



MEDIDA	EAN	REF	COD	unid.	PVP
Ø115 mm	6925582129755	HSU012501	0879	12	6,14 €
Ø115 mm	6925582129762	HSU025001	0309	12	11,74 €

ESCUADRA MAGNÉTICA PARA SOLDAR
AMWH25031
COD 0603
PVP: 3,44 €



- Sujeta piezas a 45°, 90° y 135°
- Fuerza de sujeción 11,33 kgf
- Medida 75 mm

EAN 6925582138436 4 unid.

ESCUADRA MAGNÉTICA PARA SOLDAR
AMWH50041
COD 0604
PVP: 5,71 €



- Sujeta piezas a 45°, 90° y 135°
- Fuerza de sujeción 22,67 kgf
- Medida 100 mm

EAN 6925582138429 4 unid.

ESCUADRA MAGNÉTICA PARA SOLDAR
AMWH75051
COD 0605
PVP: 10,30 €



- Sujeta piezas a 45°, 90° y 135°
- Fuerza de sujeción 34,01 kgf
- Medida 125 mm

EAN 6925582138412 4 unid.

6 PCS ESCUADRA MAGNÉTICA PARA SOLDAR
AMWH6001
COD 0606
PVP: 11,35 €



- Sujeta piezas a 45°, 90° y 135°
- 2 PCS 75 mm Fuerza de sujeción 11,33 kgf
- 4 PCS mini Fuerza de sujeción 4,53 kgf

EAN 6925582150162 4 unid.

PERFORADOR MANUAL REVÓLVER
HLHP01
COD 0114
PVP: 7,46 €



- Perforador: 2,5 mm / 3 mm / 3,5 mm / 4 mm / 4,5 mm / 5 mm

EAN 6928073670897 12 unid.

GRAPADORA MANUAL
HSG14018
COD 0620
PVP: 9,85 €



- Fuerza ajustable
- Admite grapas 11,3 x 0,7 mm y largo 4-14 mm

EAN 6941640169150 6 unid.

PISTOLA SILICONA CREMALLERA
HCG0309
COD 0149
PVP: 4,57 €

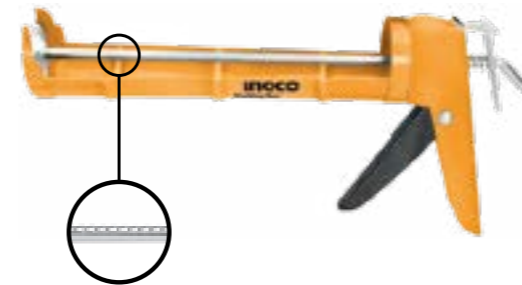

- 9" 235 mm
- Cremallera

EAN 6928073671887 12 unid.

PISTOLA SILICONA CREMALLERA
HCG0909
COD 0150
PVP: 7,31 €



- 9" 235 mm
- Cremallera

EAN 6928073680308 12 unid.

PISTOLA SILICONA
HCG1409
COD 0151
PVP: 5,24 €



- 9" 235 mm

EAN 6925582108880 12 unid.

PISTOLA SILICONA
HCG1709
COD 0152
PVP: 9,22 €



- Antigoteo de 9" 235 mm

EAN 6925582104226 12 unid.

PISTOLA MORTERO
HCG0109
COD 0485
PVP: 11,22 €



- Pistola 300-9" x 235 mm

EAN 6928073671894 4 unid.

PISTOLA MORTERO
HCG0115
COD 0148
PVP: 14,34 €



- Pistola 600 - 15" 375 mm

EAN 6928073671900 4 unid.

REMACHADORA

COD 0111

HR101

PVP: 8,42 €



- Remachadora manual acero 10"
- Incluye 3 boquillas adicionales

EAN 6928073661215 6 unid.

REMACHADORA

COD 0112

HR104

PVP: 5,62 €



- Remachadora manual acero 10,5"
- Incluye 3 boquillas adicionales

EAN 6928073680803 6 unid.

REMACHADORA

COD 0113

HR105

PVP: 10,26 €



- Remachadora manual aluminio 10,5"
- Incluye 3 boquillas adicionales

EAN 6928073684122 6 unid.

REMACHADORA

COD 0878

HR081

PVP: 16,32 €



- Remachadora manual acero 8"
- Incluye 3 boquillas adicionales

EAN 6941640156600 12 unid.

REMACHADORA GIRATORIA 360°

COD 0879

SHHR106

PVP: 16,14 €



- Remachadora manual aluminio giratoria 10,5"
- Incluye 3 boquillas adicionales

EAN 6925582128079 12 unid.

REMACHADORA DOS MANOS

COD 0695

HR171

PVP: 15,15 €



- Acero aluminizado
- Incluye 3 boquillas adicionales
- Medida 420 mm
- Caja cartón INGCO

EAN 6928073671689 20 unid.

HERRAMIENTAS DE MEDICIÓN

CATÁLOGO 2023

FLEXÓMETRO BASIC COD 0330
 HSMT08331E PVP: 2,03 €



- Doble botón
- Diseño INGCO

EAN	6925582142747		12 unid.
Largo / ancho	3 m x 16 mm		
Material	ABS		

FLEXÓMETRO BASIC COD 0331
 HSMT083521E PVP: 3,05 €



- Doble botón
- Diseño INGCO

EAN	6925582144956		12 unid.
Largo / ancho	5 m x 19 mm		
Material	ABS		

FLEXÓMETRO PRO COD 0336
 HSMT08081E PVP: 6,47 €



- Autobloqueo
- Doble botón
- Cobertura de goma
- Diseño INGCO

EAN	6925582144932		12 unid.
Longitud	8 m x 25 mm		

FLEXÓMETRO PRO COD 0337
 HSMT08101E PVP: 8,10 €



- Autobloqueo
- Doble botón
- Cobertura de goma
- Diseño INGCO

EAN	6925582142730		6 unid.
Longitud	10 m x 25 mm		

FLEXÓMETRO BASIC COD 0332
 HSMT08351E PVP: 3,59 €



- Doble botón
- Diseño INGCO

EAN	6925582144949		12 unid.
Largo / ancho	5 m x 25 mm		
Material	ABS		

FLEXÓMETRO PRO COD 0333
 HSMT08031E PVP: 2,70 €



- Autobloqueo
- Doble botón
- Cobertura de goma
- Diseño INGCO

EAN	6925582143843		12 unid.
Largo / ancho	3 m x 16 mm		

FLEXÓMETRO DOBLE CARA COD 0696
 HSMT880521E PVP: 5,90 €



- Hoja de nylon
- Impresión métrica doble cara
- Doble gancho de hoja
- Doble blister
- Longitud 5m x 19mm
- Diseño INGCO

EAN	6941640124456		5 unid.
-----	---------------	--	---------

FLEXÓMETRO DOBLE CARA COD 0697
 HSMT88051E PVP: 6,82 €



- Hoja de nylon
- Impresión métrica doble cara
- Doble gancho de hoja
- Doble blister
- Longitud 5m x 25mm
- Diseño INGCO

EAN	6941640123299		5 unid.
-----	---------------	--	---------

FLEXÓMETRO PRO COD 0334
 HSMT080521E PVP: 3,97 €



- Autobloqueo
- Doble botón
- Cobertura de goma
- Diseño INGCO

EAN	6925582143850		12 unid.
Longitud	5 m x 19 mm		

FLEXÓMETRO PRO COD 0335
 HSMT08051E PVP: 4,53 €



- Autobloqueo
- Doble botón
- Cobertura de goma
- Diseño INGCO

EAN	6925582142723		12 unid.
Longitud	5 m x 25 mm		

MEDIDOR LÁSER COD 0176
 HLDD0608 PVP: 75,60 €



- 0,05 - 60 m + -1,5 mm
- 2 x 1,5 V AAA



EAN	6925582132328		1 unid.
-----	---------------	--	---------

NIVEL LASER AUTONIVELANTE

COD 0698

HLL306505

PVP: 155,53 €

5 Line Red Laser Beams



- Rango de trabajo 0 ~ 30 m
- 1 línea horizontal y 4 líneas verticales
- Precisión de nivelación ± 1,0 mm a 5 m
- Precisión de línea ± 1,5 mm a 5 m
- Tiempo de nivelación <3 s
- Rango de autonivelación ≤3°
- Tipo de láser: rojo
- Clase de láser 3R <5 mW
- Con función de bloqueo cruzado
- Pilas AA (1,5 V) * 4

EAN 6925582146387 8 unid.

NIVEL ANTICHOC

COD 0700

HBSL08040

PVP: 17,06 €



EAN 6941640147134 20 unid.

Longitud 40 cm

NIVEL ANTICHOC

COD 0410

HBSL08060

PVP: 19,03 €



EAN 6925582122756 20 unid.

Longitud 60 cm

TRIPODE LASER

COD 0699

HLLT01152

PVP: 36,65 €

5/8"+1/4" Thread



- Aluminio
- Peso 1 Kg
- Medida 1,2 m

EAN 6925582140064 9 unid.

Longitud 60 cm

NIVEL



LONGITUD	EAN	REF	COD	Unid.	PVP
30 cm	6925582112573	HSL08030	0255	20	8,46 €
40 cm	6925582112580	HSL08040	0256	20	9,70 €
60 cm	6925582112597	HSL08060	0273	20	13,96 €
80 cm	6925582110791	HSL08080	0257	20	16,59 €
100 cm	6925582112603	HSL08100	0258	20	19,32 €

NIVEL MAGNÉTICO



- Doble cara fresada
- 0,5 Mm/m viales precisos
- Espesor: 1,5 mm



Imanes	LONGITUD	EAN	REF	COD	unid.	P.V.P	Imanes	LONGITUD	EAN	REF	COD	unid.	P.V.P
2	30 cm	6925582126150	HSL38030M	0318	20	11,16 €	4	100 cm	6925582120745	HSL38100M	0322	20	24,54 €
2	40 cm	6925582116755	HSL38040M	0319	20	12,28 €	4	120 cm	6925582120714	HSL38120M	0411	20	29,37 €
3	60 cm	6925582116731	HSL38060M	0320	20	17,86 €	4	150 cm	6925582122022	HSL38150M	0412	20	34,63 €
4	80 cm	6925582116748	HSL38080M	0321	20	21,42 €							

NIVEL MAGNÉTICO DIGITAL

COD 0486

HSL08060D

PVP: 76,96 €



- Medidas: 60 cm
- Aviso sonoro a 0°, 45° y 90°
- Lectura temperatura ambiente
- Indicador de batería
- Pantalla LCD con iluminación led
- Botón Mode: Conversión automática porcentaje, grados o pulgadas
- Función recalibrado

EAN 6925582127331 20 unid.

TRANSPORTADOR DE ANGULOS DIGITAL

COD 0701

HDAR20701

PVP: 24,82 €



- Rango: 180° 0-200mm, 360° 0-400mm
- Lectura 0,05°, 0,1 mm / 0,01"
- Batería 3V
- Conversión de sistema métrico / pulgadas en cualquier posición

EAN 6941640163493 10 unid.

ESCUADRA INOXIDABLE

COD 0487

HAS123002

PVP: 9,29 €

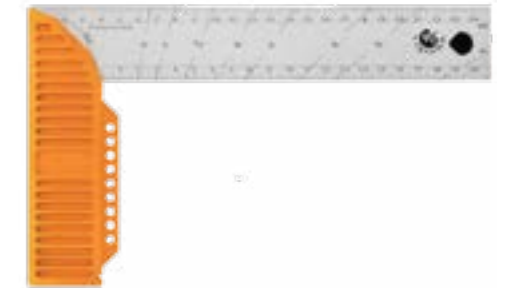

- Medidas: 300 mm
- Ancho hoja: 40 mm
- Grueso hoja: 1,5 mm
- Hoja de acero inoxidable
- Mango de polímero
- Pulgadas y métrico
- Preparada para marcar diferentes ángulos

EAN 6925582137675 12 unid.

REGLA NIVEL MULTIFUNCIÓN

COD 0625

HSR36003

PVP: 13,63 €

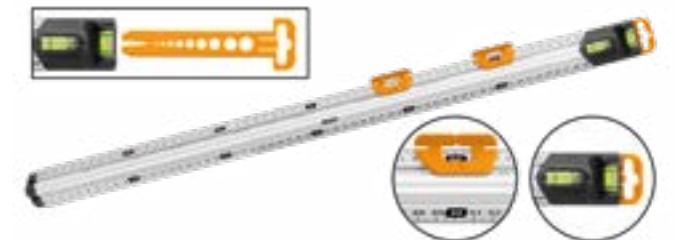

- Estructura aluminio triangular 60 cm
- Función nivel
- Centrar: Escala 0 y con centro marcado
- 2 Marcadores con guía de corte deslizantes
- Pinza extraíble con marcador diámetro brocas
- Escala marcada para enchufes y grifos
- Uña agarre para clavar fácil

EAN 6925582144253 12 unid.

REGLA CON ESCUADRA MAGNÉTICA

COD 0626

HSR530255

PVP: 35,20 €



- Medida 300 x 25 x 2 mm
- Función nivel
- Ajuste de bloqueo magnético
- Hoja de acero inoxidable
- Angulo 90°, 45°
- Marcador acero inoxidable.

EAN 6925582144260 5 unid.

PIE DE REY

COD 0488

HVC01200

PVP: 25,04 €



- Medidas: 200 mm
- Fabricado en acero al carbono
- Con guía para medición de profundidad
- Caja plástica sólida

EAN 6928073667675 10 unid.

MULTÍMETRO DIGITAL

COD 0351

DM7502

PVP: 44,94 €



- Prueba de diodo
- Luz led incorporada
- Indicador de batería
- Detección de voltaje sin contacto
- 10A ± 1.5% +3
- 10A ± 1.2% +3
- 100mf ± 5.0% + 3
- 60MΩ ± 1.0% + 30
- AC Voltaje: 6V/60V ± 0.8% + 3
- 600V/750V ± 1.0% + 10
- DC Corriente: 60mA/60mA/600mA ± 0.8% + 3
- DC Voltaje: 600mV/6V/60V/600V/1000V ± 0.5% +3
- AC Corriente: 60mA/600mA ± 1.0%+3
- Resistencia: 600Ω/6kΩ/60kΩ/600kΩ/6MΩ ± 0.8% +3
- Capacidad: 6nf ± 4.0% + 30 60nf/600nf/60F/600F/6mf ± 4.0% + 3
- Frecuencia: 9.999Hz/99.99Hz/999.9Hz/9.999KHz/99.99KHz/999.9KHz /9.999M Hz ± 1.0% + 3
- Ciclo de trabajo: 5%~95% ± 2.0% +3)

EAN 6925582135046 5 unid.

PINZA AMPERIMÉTRICA

COD 0352

DCM10004

PVP: 94,94 €



- Frecuencia: 0~ 10KHz ±(1.5% +5)
- Memoria / luz de fondo pantalla / luz de flash
- AC Corriente: 60A/600A/1000A ± (2.0% +6)
- AC Voltaje: 60mV/600mV/6V/60V/600V ± (0.8% +3) / 750V ± (1% + 4)
- DC Voltaje: 60mV/600mV/6V/60V/600V ± (0.7% +3) / 1000V±(0.8% + 2)
- Resistencia: 600Ω/6kΩ/60kΩ/600kΩ/6MΩ ± (0.8% + 3) / 60MΩ ± (1.2% + 3)
- Capacidad: 10nF/100nF/1000nF/10000nF/100000nF/1000000nF/100mF/100mF ± (4.0% + 5)

EAN 6941640122766 1 unid.

PIE DE REY DIGITAL

COD 0489

HDCD01150

PVP: 49,96 €



- Medidas: 150 mm
- Fabricado en acero al carbono
- Pantalla LCD clara
- Selección de milímetros y pulgadas
- Elevada precisión de medición ± 0,01 mm
- Con guía para medición de profundidad
- Caja de plástico sólida

EAN 6928073662830 10 unid.

MULTÍMETRO DIGITAL

COD 0702

DM200

PVP: 20,35 €



- Prueba de diodos
- LCD con retroiluminación
- Voltaje DC 200mV / 2V / 20V / 200V / 600V
- Voltaje CA 200 V / 600 V
- Corriente DC 20mA / 200mA / 10A
- Resistencia 200Ω / 2kΩ / 20kΩ / 200kΩ / 2MΩ / 20MΩ
- Indicación de batería baja
- Apagado automático

EAN 6925582149173 10 unid.

DETECTOR DE CORRIENTE SIN CONTACTO

COD 0105

VD10003

PVP: 13,00 €

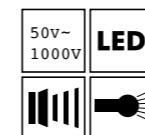

EAN 6925582131406 1 unid.

DETECTOR DE CORRIENTE 12 - 250 V

COD 0106

HSDT1908

PVP: 1,29 €

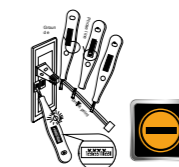

EAN 6925582114928 12 unid.

HERRAMIENTA NEUMÁTICA/ TALLER

CATÁLOGO 2023

MANGUERA NEUMÁTICA

COD 0611

AH1051

PVP: 8,39 €



- Medida 5 m
- Conectores rápidos.
- Resistencia a la flexión y al desgaste

EAN 6928073666210 5 unid.
Presión máxima 12 bar (174 PSI)

MANGUERA NEUMÁTICA

COD 0612

AH1101

PVP: 13,67 €



- Medida 10 m
- Conectores rápidos.
- Resistencia a la flexión y al desgaste

EAN 6928073666227 5 unid.
Presión máxima 12 bar (174 PSI)

CLAVADORA-GRAPADORA NEUMÁTICA 2 EN 1 COD 0610

ACN50401

PVP: 56,24 €



- Capacidad de carga de 100 unidades
- Tamaño de Brad: 15-50 mm
- Tamaño de la grapa: 16-40 mm
- Ga18, 1.25X1.0mm
- Presión 0.4-0.7Mpa (60-100Psi)
- Contiene 1.000 clavos y 1.000a grapas

EAN 6928073601594 5 unid.
Presión máxima 12 bar (174 PSI)

PISTOLA DE INFLADO

COD 0214

ATG0601

PVP: 17,19 €



- Pistola de aire del neumático inflado
- Embalado por ampolla single

EAN 6928073678008 5 unid.
Presión máxima 12 bar (174 PSI)

PISTOLA DE AIRE

COD 0607

ABG031

PVP: 4,19 €



- Longitud boquilla 16 mm

EAN 6928073600597 25 unid.

PISTOLA DE PETROLEAR

COD 0193

AWG1001

PVP: 15,25 €



- 0,75 l
- Pack indivisible 2 unidades
- 180 l/min

EAN 6925582115215 2 unid.

CONJUNTO DE HERRAMIENTAS DE AIRE 5 PCS COD 0211
AKT0053
PVP: 42,12 €

• Herramientas de aire

EAN	6941640129802		10 unid.
-----	---------------	--	----------

PISTOLA IMPACTO 3/4" COD 0195
AIW341301
PVP: 181 €

• Reversible

EAN	6925582108361		1 unid.
-----	---------------	--	---------

Velocidades	7.000 RPM
Consumo de aire	269 l/min
Máx. torque	1.365 Nm
Presión de trabajo	6,2 Bar
Peso	3 Kg

GUANTE DE NITRILO TALLA L (9) / XL (10) COD 0191 - 0192
HGNG01
PVP: 1,31 €

EN388 4121

• Pack indivisible 12 unid.

EAN	6925582117677		12 unid.
EAN	6925582115192		12 unid.

PISTOLA IMPACTO 1/2" COD 0194
AIW12562
PVP: 92,10 €

• Reversible

EAN	6925582127010		1 unid.
-----	---------------	--	---------

Velocidades	7.500 RPM
Consumo de aire	142 l/min
Máx. torque	567 Nm
Presión de trabajo	6,2 Bar
Peso	2,6 Kg

LLAVE IMPACTO ELÉCTRICA COD 0267
IW10508
PVP: 138 €

• Reversible

• Maleta de plástico

EAN	6925582115208		2 unid.
-----	---------------	--	---------

Velocidades	0 - 2.300 RPM
Inserción	1/2"
Máx. torque	550 Nm

CHAQUETA IMPERMEABLE L/XL/XXL

TALLA	EAN	REF	COD	Unid.	PVP
L	6925582143539	HJATL2281	0882	1	35,80 €
XL	6925582143669	HJATL2281	0883	1	35,80 €
XXL	6925582143676	HJATL2281	0884	1	35,80 €

LINTERNAS

CATÁLOGO 2023

LINTERNA LED

HFL012AA1



- 70 lúmenes 150 m
- Aluminio Waterproof
- 10 horas
- Utiliza 2 unid.AA - 1,5 V
- Diámetro / Largo 27.5 mm / 158.3 mm

EAN 6925582113235 6 unid.

COD 0181

PVP: 14,24 €

LINTERNA LED

HFL013AAA1



- 135 lúmenes 200 m
- Aluminio Waterproof
- 12 horas
- Utiliza 3 unid.AAA - 1,5 V
- Diámetro / Largo 32 mm / 126,5 mm

EAN 6925582113228 6 unid.

COD 0182

PVP: 16,82 €

LINTERNA LED BATERÍA LION

HCFL186503



- 270 lúmenes 200 m
- 8 horas
- Largo 16,5 mm
- Incluye cargador
- Entrada mechero
- Entrada USB

EAN 6925582113259 6 unid.

Batería LITIO ION

COD 0183

PVP: 48,08 €

LINTERNA LED

HFL013D1



- 250 lúmenes 270 m
- Aluminio Waterproof
- 60 horas
- Utiliza 3 unid.xD - 1,5 V
- Diámetro / Largo 57,5 mm / 327,7 mm

EAN 6925582113242 3 unid.

COD 0184

PVP: 33,36 €

LINTERNA FRONTAL

HHL013AAA2

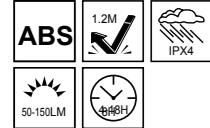

- 50 - 150 lúmenes
- IPx4
- ABS
- 4 - 18 horas
- Utiliza 3 unid.AAA - 1,5 V

EAN 6925582122497 6 unid.

COD 0185

PVP: 15,66 €

LAMPARA TALLER

HWLI35261



- Batería recargable de li iion
- 75-300 lúmenes
- Disipación de potencia led 3,5 W
- Incluye cargador usb

EAN 6941640158000 6 unid.

COD 0703

PVP: 29,29 €

HERRAMIENTA JARDÍN

CATÁLOGO 2023

TRONZADORA PLEGABLE

COD 0186

HFSW1808

PVP: 8,64 €



- 7" 180 mm
- Triple afilado

EAN 6925582123548 6 unid.

SIERRA TRONZADORA

COD 0187

HPS3008

PVP: 10,90 €



- 12" 300 mm

EAN 6925582123081 6 unid.

SIERRA TRONZADORA

COD 0188

HPS3308

PVP: 11,24 €



- 13" 330 mm
- Adaptable a alargadera (no incluida)

EAN 6925582123951 6 unid.

ARCO TRONZADOR

COD 0189

HBS6101

PVP: 10,75 €



- 24" 610 mm

EAN 6925582123081 6 unid.

TIJERA CORTASETOS

COD 0261

HHS6001

PVP: 16,81 €



- Material: acero carbono
- Tratamiento térmico

EAN 6928073672211 6 unid.

Longitud 600 mm / 23.5"

TIJERA DE PODAR A DOS MANOS

COD 0262

HLT7101

PVP: 17,35 €



- Material: acero carbono
- Tratamiento térmico

EAN 6928073673102 6 unid.

Longitud 710 mm / 28"

TIJERA DE PODAR A DOS MANOS

COD 0263

HLT7401

PVP: 22,10 €



- Material: Acero carbono.
- Tratamiento térmico.
- Longitud 740mm / 29"

EAN 69280736737686 1 unid.

PODADERA

COD 0260

CARETA

COD 0259

HPS0308

PVP: 10,85 €

HFSPC01

PVP: 8,90 €



- Cuchilla de alta calidad

EAN 6925582101645 12 unid.

Tamaño 8" / 205 mm



- Pantalla de protección transparente

EAN 6925582112757 20 unid.

HERRAMIENTAS PINTOR

CATÁLOGO 2023

PALETINA MANGO PLÁSTICO



MEDIDAS (ancho x largo x grueso)	EAN	REF	COD	unid	PVP
25 x 45 x 10 mm	6925582126372	CHPTB68701	0490	12	0,66 €
38 x 45 x 11 mm	6925582126419	CHPTB68715	0491	12	0,88 €
50 x 51 x 11 mm	6925582126389	CHPTB68702	0492	12	1,39 €
75 x 57 x 12 mm	6925582126396	CHPTB68703	0493	12	2,56 €
100 x 57 x 14 mm	6925582126402	CHPTB68704	0494	12	3,51 €

PALETINA MANGO FIBRA DE VIDRIO



MEDIDAS (ancho x largo x grueso)	EAN	REF	COD	unid	PVP
25 x 51 x 16 mm	6925582113297	CHPTB8701	0501	12	1,82 €
38 x 51 x 18 mm	6925582114508	CHPTB8715	0502	12	2,24 €
50 x 57 x 18 mm	6925582113303	CHPTB8702	0503	12	3,31 €
63 x 57 x 20 mm	6925582113310	CHPTB8725	0504	12	4,36 €
75 x 64 x 22 mm	6925582113327	CHPTB8703	0505	12	5,98 €
100 x 70 x 22 mm	6925582113334	CHPTB8704	0506	12	8,39 €

RODILLO 100 MM COMPLETO HRHT061001D PVP: 2,42 € COD 0509



- Microfibra
- Mango fibra ergonómico INGCO
- Embalado bolsa plástico

EAN	6925582122244	50 unid.
Medida		100 mm
Largo fibra		12 mm
Varilla		6 mm

PALETINA MANGO FIBRA DE VIDRIO

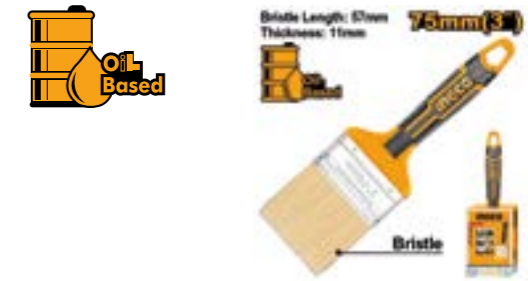

MEDIDAS (ancho x largo x grueso)	EAN	REF	COD	unid	PVP
25 x 51 x 8 mm	6925582139488	CHPTB8601	0495	12	1,24€
38 x 51 x 9 mm	6925582139495	CHPTB8615	0496	12	1,57 €
50 x 51 x 10 mm	6925582139501	CHPTB8602	0497	12	2,04 €
63 x 57 x 10 mm	6925582139518	CHPTB8625	0498	12	2,91 €
75 x 57 x 11 mm	6925582139525	CHPTB8603	0499	12	3,46 €
100 x 57 x 12 mm	6925582139532	CHPTB8604	0500	12	4,56 €

RODILLO ESPECIAL ESQUINAS COMPLETO COD 0507

- HRHT360501C PVP: 3,12 €**
- Microfibra
 - Mango fibra ergonómico INGCO
 - Embalado bolsa plástico

EAN	6925582132847	40 unid.
Medida		50 mm
Largo fibra		8 mm
Varilla		6 mm

RECAMBIO RODILLO ESPECIAL ESQUINAS COD 0508

- HRC3305008 PVP: 1,61 €**
- Microfibra
 - Embalado bolsa plástico

EAN	6925582135992	100 unid.
Medida		50 mm
Largo fibra		8 mm

RECAMBIO RODILLO 100 MM COD 0510

- HRC3610012 PVP: 0,57 €**

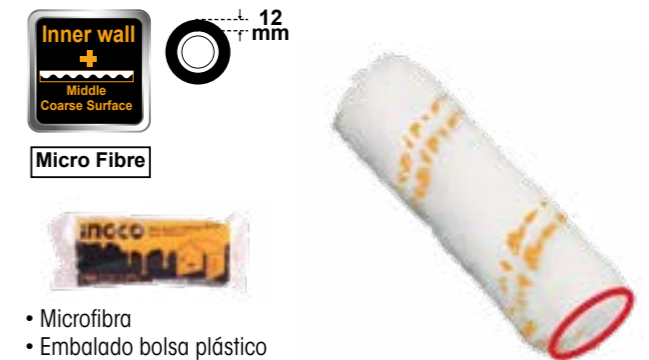

- Microfibra
- Embalado bolsa plástico
- Pack indivisible 10 u

EAN	6925582118384	10 unid.
Medida		100 mm
Largo fibra		12 mm

RODILLO 230 MM COMPLETO

HRHT042301D

COD 0511

PVP: 4,61 €



Micro Fibre

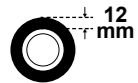

- Microfibra
- Mango fibra ergonómico INGCO
- Embalado bolsa plástico

EAN	6925582122237		20 unid.
Medida	230 mm		
Largo fibra	12 mm		
Varilla	6 mm		

RODILLO 230 MM COMPLETO

HRHT042302D

COD 0513

PVP: 5,95 €



Micro Fibre

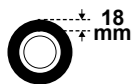

- Microfibra
- Mango fibra ergonó
- Embalado bolsa plástico

EAN	6925582122923		20 unid.
Medida	230 mm		
Largo fibra	18 mm		
Varilla	8 mm		

RODILLO 255 MM COMPLETO

HRHT092551

COD 0515

PVP: 7,11 €



Acrylic

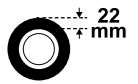

- Acrílico
- Mango fibra ergonómico INGCO
- Embalado bolsa plástico

EAN	6925582107050		20 unid.
Medida	255 mm		
Largo fibra	22 mm		
Varilla	8 mm		

RECAMBIO RODILLO 230 MM

HRC3323014

COD 0512

PVP: 2,19 €



Micro Fibre

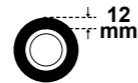

- Microfibra
- Embalado bolsa plástico

EAN	6925582118360		50 unid.
Medida	230 mm		
Largo fibra	12 mm		

RECAMBIO RODILLO 230 MM

HRC3323018

COD 0514

PVP: 2,61 €



Micro Fibre

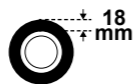

- Microfibra
- Pack indivisible 10 unid.
- Embalado bolsa plástico

EAN	6925582118407		50 unid.
Medida	230 mm		
Largo fibra	18 mm		

RECAMBIO RODILLO 255 MM

HRC0925522

COD 0516

PVP: 4,26 €



Acrylic

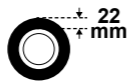

- Acrílico
- Embalado bolsa plástico

EAN	6925582107067		50 unid.
Medida	255 mm		
Largo fibra	22 mm		







ÍNDICE

133 - 137	HERRAMINETAS DE PODA
138	HACHAS Y MAZA
139	MOTOAZADAS
140	DESBROZADORAS Y CORTACESPED
141 - 143	ACCESORIOS Y CONSUMIBLES MOTOAZADAS Y DESBROZADORAS
144 - 145	PULVERIZADORES
146 - 150	HERRAMIENTAS JARDÍN
151 - 152	CALZADO DE SEGURIDAD
153 - 154	GUANTES DE PROTECCIÓN
155	COMPRESORES SILENCIOSOS
156	LIMPIADORAS ALTA PRESIÓN

TIJERAS DE PODA 1 MANO

S2715

PVP: 23,30 €



- Capacidad de corte: 25mm.
- Cuerpo de aluminio forjado.
- Mangos ergonómicos y antideslizantes.
- 210mm

EAN 5602796033580 10 unid.

TIJERAS DE PODA 1 MANO

S3026

PVP: 22,77 €



- Capacidad de corte: 25mm.
- Cuerpo de aluminio forjado.
- Mangos ergonómicos y antideslizantes.
- 210mm

EAN 5602796045088 10 unid.

TIJERAS DE PODA 1 MANO

S2525

PVP: 23,30 €



- Capacidad de corte: 25mm.
- Cuerpo de aluminio forjado.
- Mangos ergonómicos y antideslizantes.
- 210mm

EAN 5602796013957 10 unid.

TIJERAS DE PODA 1 MANO

S1676F

PVP: 25,97 €



- Capacidad de corte: 25mm.
- Cuerpo de aluminio forjado, ligero y confortable.
- Mango giratorio, ergonómico y antideslizante.
- Dos posiciones de corte.
- 210mm

EAN 5602796047341 10 unid.

TIJERAS DE PODA 1 MANO

S2050

PVP: 18,43 €



- Capacidad de corte: 25mm.
- Hoja de acero SK5.
- Mangos de acero perfilado.
- 230mm

EAN 5602796012257 10 unid.

TIJERAS DE PODA 1 MANO

S3600-230

PVP: 15,67 €



- Capacidad de corte: 25mm.
- Mangos de fibra y ergonómicos.
- 230mm

EAN 5602796047358 10 unid.

TIJERAS DE VENDIMIA

S3620C

PVP: 8,53 €



- Cuerpo de acero inoxidable.
- Mangos antideslizantes.
- Hoja y contra hoja de acero inoxidable.
- 185mm

EAN 5602796058262 10 unid.

TIJERAS DE VENDIMIA

S3620D

PVP: 8,53 €



- Cuerpo de acero inoxidable.
- Hoja recta de acero inoxidable.
- Mangos antideslizantes.
- 185mm

EAN 5602796061705 10 unid.

TIJERAS DE PODA 2 MANOS

S3642 PVP: 32,58 €



- Para Poda Verde, corte limpio.
- Capacidad de corte: 35mm.
- Mangos extensibles de aluminio
- Empuñaduras de goma.
- Hoja de acero forjado.
- Estructura ligera y fácil de usar.
- Extensible de 65 a 90 cm

EAN 5602796059641 10 unid.

TIJERAS DE PODA 2 MANOS

S3641 PVP: 26,51 €



- Para Poda Verde, corte limpio.
- Capacidad de corte: 40mm.
- Mangos de aluminio
- Empuñaduras de goma.
- Hoja de acero forjado.
- 83 cm

EAN 5602796059634 10 unid.

TIJERAS DE PODA 2 MANOS

S2160 PVP: 51,10 €



- Para Poda Verde, corte limpio.
- Capacidad de corte: 40mm.
- Mangos extensibles de aluminio
- Empuñaduras de goma.
- Sistema multiplicador de fuerza.
- Contrahoja dentada para mayor estabilidad de corte.
- Extensible de 66,5 a 100 cm

EAN 5602796012981 10 unid.

TIJERAS DE PODA 2 MANOS

S3041 PVP: 41,27 €



- Para Poda Verde, corte limpio.
- Con multiplicador de fuerza
- Capacidad de corte: 40mm.
- Mangos metálicos extensibles.
- Empuñadura de esponja
- Hoja con revestimiento antiadherente para un corte limpio y sin esfuerzo.
- Contrahoja dentada para mayor estabilidad de corte.
- Extensible de 64,5 a 97cm

EAN 5602796045385 10 unid.

TIJERAS DE PODA 2 MANOS

S2073 PVP: 28,16 €



- Capacidad de corte: 35mm.
- Mangos metálicos extensibles.
- Empuñadura de esponja.
- Hoja con revestimiento antiadherente para un corte limpio y sin esfuerzo.
- Contrahoja dentada para mayor estabilidad de corte.
- Extensible de 66,5 a 100cm

EAN 5602796012493 10 unid.

TIJERAS DE PODA 2 MANOS

S1580 PVP: 31,80 €



- Para Poda Verde, corte limpio.
- Capacidad de corte: 38mm.
- Mangos metálicos extensibles.
- Empuñadura de esponja
- Hoja con revestimiento antiadherente para un corte limpio y sin esfuerzo.
- Extensible de 65 a 95 cm

EAN 5602796006287 10 unid.

TIJERAS DE PODA 2 MANOS

S1675 PVP: 35,47 €



- Para Poda Seca
- Mangos metálicos extensibles.
- Empuñadura de esponja.
- Hoja con revestimiento antiadherente para un corte limpio y sin esfuerzo.
- Extensible de 66,5 a 96,5cm

EAN 5602796007345 10 unid.

TIJERAS DE PODA 2 MANOS
S2072
PVP: 40,33 €

- Para Poda Seca
- Corte: 35mm.
- Mangos metálicos extensibles.
- Empuñadura de esponja.
- Hoja con revestimiento antiadherente para un corte limpio y sin esfuerzo.
- Extensible de 66,5 a 96cm

EAN 5602796012486 10 unid.

HERRAMIENTA DE PODA ALTA
S1579
PVP: 26,77 €

- Con Sierra
- Corte: 32mm.
- Mango de madera.
- Hoja de sierra en acero SK5 c/ 325mm.
- Hoja con revestimiento antideslizante.
- Con hoja.

EAN 5602796012462 10 unid.

HERRAMIENTA DE PODA ALTA
S3029
PVP: 63,37 €

- Corte: 35mm.
- Mango metálico extensible hasta 3 m.
- Empuñadura y cuerda ABS con sistema de poleas.
- Hoja de acero SK5 de 325 mm.
- Hoja con revestimiento antideslizante.
- Sistema multiplicador de fuerza.

EAN 5602796045125 10 unid.

HERRAMIENTA DE PODA ALTA
S1584
PVP: 53,57 €

- Corte: 32mm.
- Mango metálico extensible hasta 3 m.
- Empuñadura de madera y cuerda con sistema de poleas.
- Hoja de acero SK5 c/ 325mm.
- Hoja con revestimiento antideslizante.

EAN 5602796006324 10 unid.

SIERRA DE PODA 1 MANO
S1763
PVP: 9,43 €

- Mango Bimaterial, Hoja Abatible
- Hoja de acero SK5.

EAN 5602796008151 10 unid.

SIERRA DE PODA 1 MANO
S1765
PVP: 10,97 €

- Mango de Madera
- Hoja de acero SK5.
- Bolsa de Protección de Plástico.
- Mango de madera barnizada.

EAN 5602796008175 10 unid.

SIERRA DE PODA ALTA
S3910
PVP: 47,30 €

EAN 5602796061637 10 unid.

SIERRA DE PODA 1 MANO
S3491-13
PVP: 12,40 €

- Mango Bimaterial, con Bolsa
- Hoja de acero SK5.

EAN 5602796051386 10 unid.

SIERRA DE ARCO
PVP: 42,12 €

- Capacidad de corte: 25mm.
- Cuerpo de aluminio forjado.
- Empuñadura antideslizante.
- Dos posiciones de corte.
- 210mm

Ref.	Medidas	EAN		unid.	PVP
S576	460mm/18"	5602796003842		10	6,85 €
S57621	533mm/21"	5602796001374		10	7,13 €
S577	610mm/24"	5602796001381		10	8,10 €
S578	760mm/30"	5602796001398		10	9,45 €
S579	914mm/36"	5602796046313		10	11,28 €

HACHA

S2081

PVP: 12,40 €



- Cabeza de acero forjado.
- Mango bimaterial

EAN 5602796012585  12 unid.

HACHA A 2 MANOS

S1689

PVP: 31,60 €



- Mango bimaterial

EAN 5602796007420  6 unid.

MAZA-CUÑA

S1690

PVP: 32,40 €



- Mango bimaterial

EAN 5602796007437  6 unid.

MOTOAZADA GASOLINA

S3517

PVP: 950 €



- Motor 4 tiempos



- Cilindrada 208 cm³
- Potencia 7 CV



- Largo 500-900 mm
- Profundidad 150-300 mm



- Transmisión directa.
- Rotación 3600 rpm



- Peso 85 kg.

- Capacidad del tanque de combustible: 3.6L
- 2 velocidades + 1 marcha atrás
- Aceite de motor: 15w40
- Capacidad del tanque de aceite: 0.6L
- Capacidad valvulina: 2L
- Caja de herramientas
- Transmisión Directa
- 7CV / 208CM3

EAN 5602796051935  1 unid.



Incluye ruedas, fresas y arado.

MOTOAZADA GASOLINA

S3423-7CV

PVP: 780 €



- Motor 4 tiempos



- Cilindrada 208 cm³
- Potencia 7 CV



- Largo 500-900 mm
- Profundidad 150-300 mm



- Transmisión por correas.
- Rotación 3600 rpm



- Peso 72 kg.

- Capacidad del tanque de combustible: 3.6L
- 2 velocidades + 1 marcha atrás
- Aceite de motor: 15w40
- Capacidad del tanque de aceite: 0.6L
- Capacidad valvulina: 1.4L
- Transmisión por correas.
- 7CV / 208CM3

EAN 5602796048676  10 unid.



Incluye ruedas, fresas y arado.

DESBROZADORA MOCHILA

S3587-43 PVP: 282,43 €

- Motor 2 tiempos
- Sistema antivibración
- Cilindrada 43 cm³
- Transmisión por correas.
- Rotación 3200 rpm/1,25 kw
- Peso 12 kg.
- Sistema de arranque manual e inteligente



- Depósito combustible 1L
- Incluye disco 3 dientes.
- Combustible: Mezcla
- Mochila de primera calidad
- Mango ergonómico
- 42.7CM3

EAN 5602796054974 1 unid.

DESBROZADORA

S3585-43 PVP: 219,88 €

- Motor 2 tiempos
- Rotación máx. 3200 rpm
- Cilindrada 43 cm³
- /1,25kw
- Sistema de arranque manual e inteligente
- Peso 7,7 kg.



- Depósito combustible 1L
- Combustible: Mezcla
- Arnés+ depósito mezcla
- Mango ergonómico antideslizante.
- Incluye disco 3 dientes.

EAN 5602746054950 1 unid.

DESBROZADORA

S3586-52 PVP: 224,01 €

- Motor 2 tiempos
- Rotación máx. 3200 rpm
- Cilindrada 52 cm³
- /1,25kw
- Sistema de arranque manual e inteligente
- Peso 7,8 kg.



- Arnés+ depósito mezcla
- Mango ergonómico antideslizante.
- Incluye disco 3 dientes.
- Depósito combustible 1L
- Combustible: Mezcla

EAN 5602796054967 1 unid.

CORTA CESPED ELECTRICA

S3677-1300 PVP: 129,87 €



- Voltagem 230-240V-50Hz
- Potência 1300w
- Rotação 3600rpm
- Diâmetro de Corte 320mm
- Peso 10.5kg
- Nivel de Ruído 96dB(A)
- 3 Níveis de Corte 30-60mm

EAN 5602796045088 1 unid.

ARADO

S3517-R PVP: 41,75 €



EAN 5602796054165 1 unid.

RUEDAS

S3423-R PVP: 19,89 €



EAN 5602796062757 1 unid.

CUCHILLA DERECHA

S3423-75-C-143 PVP: 3,14 €



EAN 5602796054196 1 unid.

CUCHILLA IZQUIERDA

S3423-75-C-142 PVP: 3,14 €



EAN 5602796054202 1 unid.

CUCHILLA DESBROZADORA 2 DIENTES

S1972 PVP: 10,15 €



- 2 dientes - 300 x 25,4 x 3 mm

EAN 5602796013568 25 unid.

CUCHILLA DESBROZADORA 3 DIENTES

S2548-300 PVP: 8,88 €



- 3 Dientes - 300 x 25.4 x 2mm

EAN 5602796004337 25 unid.

CUCHILLA DESBROZADORA 3 DIENTES

S2817 PVP: 13,21 €



- 3 dientes - 300 x 25,4 x 3 mm

EAN 5602796035546 25 unid.

DISCO DESBROZADORA WIDIA



- Disponible Cerrado o Ventilado.

Ref.	Medidas	EAN	unid.	PVP
S215/36	Dientes - 255 x 25.4 x 2mm	5602796006645	25	8,27 €
S215/40	Dientes - 255 x 25.4 x 2mm	5602796006652	25	8,84 €

DISCO DESBROZADORA WIDIA



Ref.	Medidas	EAN	unid.	PVP
S3516-16	Dientes - 250 x 25.4 x 2mm	5602796052413	25	12,09 €
S3516-20	Dientes - 250 x 25.4 x 2mm	5602796052420	25	13,21 €

CABEZALES DE CORTE PARA DESBROZADORA

- Tope de aluminio.
- Cuerpo de plástico.
- Base inferior de acero.
- Recarga rápida y fácil.



Ref.	Medidas	EAN	unid.	PVP
S3607-08	2, 2.4 e 3mm	5602796051140	10	11,52 €

CABEZALES DE CORTE PARA DESBROZADORA

- Tope y cuerpo de plástico



Ref.	Medidas	EAN	unid.	PVP
S3411-06	2, 2.4 e 3mm	5602796047990	10	8,25 €

DISCO DESBROZADORA WIDIA



- Disponible Cerrado o Ventilado.

Ref.	Medidas	EAN	unid.	PVP
S3604-15	Dientes - 250 x 25.4 x 2mm	5602796047792	25	7,38 €
S3604-20	Dientes - 250 x 25.4 x 2mm	5602796047808	25	7,76 €
S3604-36	Dientes - 250 x 25.4 x 2mm	5602796047815	25	8,95 €
S3604-40	Dientes - 250 x 25.4 x 2mm	5602796047822	25	9,30 €

DISCO DESBROZADORA WIDIA



Ref.	Medidas	EAN	unid.	PVP
S3606-48	Dientes - 255 x 25.4 x 2mm	5602796049574	25	13,21 €

CABEZALES DE CORTE PARA DESBROZADORA

- Cuerpo de aluminio.
- Incluye llave hexagonal, dos arandelas y cordón de nailon.



Ref.	Medidas	EAN	unid.	PVP
S2491	Grande	5602796013582	20	11,69 €
S2490	Pequeña	5602796013575	20	7,82 €

CABEZALES DE CORTE PARA CORTADORA



- Cuerpo de aluminio.
- Incluye llave hexagonal, dos arandelas y cordón de nailon.

Ref.	Medidas	EAN	unid.	PVP
S2635	2, 2.4 e 3mm	5602796019225	12	7,82 €

HILOS DE NYLON PARA CABEZAL DE CORTE.



- Cuadrado

Ref.	Medidas	EAN	unid.	PVP
S2622	1.3mm x 15m	5602796019072	12	1,04 €
S2623	1.3mm x 50m	5602796019089	12	2,22 €
S2624	1.6mm x 15m	5602796019096	12	1,18 €
S2625	1.6mm x 50m	5602796019102	12	2,99 €
S2633	2.4mm x 15m	5602796019201	12	2,42 €
S2277	2.4mm x 50m	5602796019119	12	5,65 €
S2626	3mm x 15m	5602796019126	12	3,06 €
S2305	3mm x 50m	5602796019133	12	8,50 €
S2634	3.3mm x 15m	5602796019218	6	3,78 €
S2627	3.3mm x 50m	5602796019140	6	11,56 €
S2628	4mm x 15m	5602796019157	6	5,02 €
S2629	4mm x 50m	5602796019164	6	16,41 €

HILO ESTRELLA DE NYLON PARA CABEZAL DE CORTE



- Estrella

Ref.	Medidas	EAN	unid.	PVP
S3605-1315	1.3mm x 15m	5602796047839	12	1,27 €
S3605-1350	1.3mm x 50m	5602796047846	12	3,72 €
S3605-1615	1.6mm x 50m	5602796047853	12	1,31 €
S3605-1650	1.6mm x 15m	5602796047860	6	1,40 €
S3605-2415	2.4mm x 15m	5602796047877	12	1,82 €
S3605-2450	2.4mm x 50m	5602796047884	6	3,76 €

PLATO PROTECCION DE DISCO



Ref.	Medidas	EAN	unid.	PVP
S18.408066	para desbrozadora	5602796042834	40	0,70 €

HILOS DE NYLON PARA CABEZAL DE CORTE.



- Redondo

Ref.	Medidas	EAN	unid.	PVP
S2544	1.3mm x 15m	5602796018969	12	1,30 €
S2545	1.3mm x 50m	5602796018976	12	2,01 €
S1572	1.6mm x 15m	5602796013315	12	2,93 €
S2546	1.6mm x 50m	5602796018983	12	2,41 €
S1574	2.4mm x 15m	5602796013339	12	2,11 €
S2274	2.4mm x 50m	5602796018990	12	4,73 €
S1574/3	3mm x 15m	5602796014114	12	2,87 €
S2273	3mm x 50m	5602796019003	12	8,16 €
S1574/3/3	3.3mm x 15m	5602796014107	12	3,45 €
S2272	3.3mm x 50m	5602796019010	6	10,07 €
S2547	4mm x 15m	5602796019027	6	4,16 €
S2620	4mm x 50m	5602796019034	6	13,74 €

- Estrella

Ref.	Medidas	EAN	unid.	PVP
S3605-3015	3mm x 15m	5602796047891	12	2,17 €
S3605-3050	3mm x 50m	5602796047907	4	5,47 €
S3605-3315	3.3mm x 15m	5602796047914	12	2,54 €
S3605-3350	3.3mm x 50m	5602796047921	6	7,35 €
S3605-4015	4mm x 15m	5602796047938	12	3,37 €

PULVERIZADOR MANUAL

S2513

PVP: 10,50 €



- Incluye una boquilla adicional.
- 2 Litros

EAN 5602796013667  12 unid.

PULVERIZADOR MANUAL

S2041

PVP: 25,35 €



- Lanza en Latón con flujo ajustable.
- Tanque con Válvula Seguridad.
- Manija de la bomba en forma de "T".
- 5 litros

EAN 5602796013520  6 unid.

PULVERIZADOR MANUAL

S2043

PVP: 26,85 €



- Lanza en Latón con flujo ajustable.
- Tanque con Válvula Seguridad.
- Manija de la bomba en forma de "T".
- 8 litros

EAN 5602796013537  6 unid.

PULVERIZADOR MANUAL

S2045-12

PVP: 33,37 €

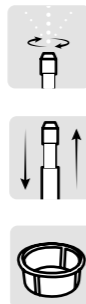

- Boquilla ajustable
- Lanza de metal Extensible.
- 12 litros

EAN 5602796054707  1 unid.

PULVERIZADOR MANUAL

S1678

PVP: 35,04 €

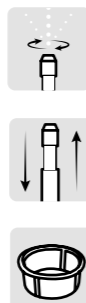

- Boquilla ajustable
- Lanza de metal Extensible.
- 16 litros

EAN 5602796007697  1 unid.

PULVERIZADOR A BATERÍA

S3701-12

PVP: 74,20 €



- Incluye juego de boquillas y juntas.
- Batería de 12V con más 4 horas de Autonomía.
- Boquilla ajustable
- Lanza de metal Extensible.
- 12 litros

EAN 5602796054691  1 unid.

PULVERIZADOR A BATERÍA LI ION

S3702-16

PVP: 107,38 €



- Incluye juego de boquillas y juntas
- Batería de 12V con más 4 horas de Autonomía.
- Boquilla ajustable
- Lanza de metal Extensible.
- 16 litros

EAN 5602796059788  1 unid.

PULVERIZADOR A BATERÍA LI ION

S3727-16

PVP: 101,92 €



- Incluye juego de boquillas y juntas.
- Batería de 12V con más 4 horas de Autonomía.
- Boquilla ajustable
- Lanza de metal Extensible.
- 16 litros

EAN 5602796062528  1 unid.

TIJERA CORTASETOS

S3643 PVP: 26,64 €



- Cables de aluminio
- Hoja recta de acero forjado.
- Empuñaduras ergonómicas antideslizantes.

EAN 5602796059658 12 unid.

TIJERA CORTASETOS

S2421 PVP: 34,70 €



- Mangos metálicos extensibles.
- Cuchilla corrugada con revestimiento antiadherente para un corte limpio y eficaz.
- Empuñadura de esponja.

EAN 5602796013353 12 unid.

TIJERA CORTASETOS

S129-10 PVP: 18,99 €



- Mangos madera
- Cuchilla corrugada.
- Empuñaduras de goma.
- Longitud: 53,3 cm

EAN 5602796006591 12 unid.

TIJERA CORTASETOS

S2859 PVP: 19,43 €



- Hoja recta.
- Longitud: 50 cm

EAN 5602796037939 12 unid.

TIJERA CORTASETOS

S1583 PVP: 31,37 €



- Mangos de aluminio
- Cuchilla corrugada con revestimiento antiadherente para un corte limpio y eficaz.
- Empuñaduras ergonómicas antideslizantes.

EAN 5602796006317 12 unid.

TIJERA CORTASETOS

S1582 PVP: 28,23 €



- Mangos metálicos
- Cuchilla corrugada con revestimiento antiadherente para un corte limpio y eficaz.
- Empuñaduras de goma.

EAN 5602796006300 10 unid.

TIJERA CORTASETOS

S129/12 PVP: 22,17 €



- Mangos madera
- Cuchilla corrugada.
- Empuñaduras de goma.
- Longitud: 58 cm

EAN 5602796000087 12 unid.

TIJERAS DE JARDÍN

S2521 PVP: 12,13 €



- Para Flores
- Cabos Bimatéria.
- hoja derecha

EAN 5602796013919 10 unid.

PELADOR DE JARDÍN

S3698 PVP: 7,31 €



- Mango bimataterial ergonómico.

EAN 5602796061767 10 unid.

PALA DE TRASPLANTE

S3693 PVP: 9,49 €



- Mango bimataterial ergonómico.

EAN 5602796061712 10 unid.

RASTRILLO DE JARDÍN

S3697 PVP: 7,09 €



- Mango bimataterial ergonómico.

EAN 5602796061750 10 unid.

CORTA RAÍCES

S3699 PVP: 7,43 €



- Mango bimataterial ergonómico.

EAN 5602796061774 10 unid.

CULTIVADOR DE JARDÍN

S3694 PVP: 7,61 €



- Mango bimataterial ergonómico.

EAN 5602796061729 10 unid.

ESCOBA DE JARDÍN

S3696 PVP: 9,26 €



- Mango bimataterial ergonómico.

EAN 5602796061743 10 unid.

PALA JARDÍN Y 3 DIENTES
S3695
PVP: 9,04 €

- Mango bimaterial ergonómico.

EAN 5602796061736 10 unid.

PLANTADOR DE MANO
S1634
PVP: 6,67 €

- Estructura de madera.
- Punta metálica.
- Longitud: 28 cm

EAN 5602796006911 10 unid.

PELADOR DE JARDÍN
S1674
PVP: 5,44 €

- En Acero Inoxidable.
- Mango de madera.

EAN 5602796007338 10 unid.

PALA DE TRASPLANTE
S1673
PVP: 6,90 €

- En Acero Inoxidable.
- Mango de madera.

EAN 5602796007314 10 unid.

TRANSPLADOR DE BULBOS
S1635
PVP: 4,85 €

- Mango bimaterial ergonómico.

EAN 5602796006928 10 unid.

PLANTADOR DE MANO LARGO
S2719
PVP: 11,40 €

- Estructura de madera.
- Punta metálica.
- Longitud: 80 cm

EAN 5602796033634 10 unid.

CULTIVADOR DE JARDÍN
S1671
PVP: 6,69 €

- Dientes de acero inoxidable.
- Mango de madera..

EAN 5602796007307 10 unid.

PALA DE TRASPLANTE LARGA
S1672
PVP: 7,41 €

- En Acero Inoxidable.
- Mango de madera.

EAN 5602796007321 10 unid.

AZADA MINI HORQUILLA

- Mango de madera..

Ref.	Medidas	EAN	unid.	PVP
S2604	3 dientes - largo 130cm	5602796015791	6	14,03 €
S2606	4 dientes - largo 130cm	5602796015814	6	19,20 €

AZADA COSECHADORA

- Azada de metal.
- Mango de madera.

Ref.	Medidas	EAN	unid.	PVP
S2613	Largo 130cm	5602796015821	6	17,96 €

RASTRILLOS

- Mango de madera
- Rastrillo metálico.

Ref.	Medidas	EAN	unid.	PVP
S589/8	8 Dientes	5602796006782	6	8,72 €
S590/C	10 Dientes	5602796006805	6	9,11 €
S591/C	12 Dientes	5602796021099	6	9,45 €
S592/C	14 Dientes	5602796021105	6	10,20 €
S593/C	16 Dientes	5602796033597	6	10,95 €

RASTRILLOS

- Diente Plano
- Cuerpo metálico.

Ref.	Medidas	EAN	unid.	PVP
S589	8 Dientes	5602796001329	12	6,03 €
S590	10 Dientes	5602796001336	12	6,71 €
S591	12 Dientes	5602796001343	12	7,38 €
S592	14 Dientes	5602796001350	12	8,28 €
S593	16 Dientes	5602796001367	12	9,58 €

ESCOBA JARDÍN



- Regulable, con mango Metálico
- Empuñadura superior de plástico.
- Escoba con 15 palos de metal.

- Escoba cerrada: 19cm (ancho).
- Escoba abierta: 55cm (ancho).
- Escoba cerrada: 125cm (longitud total con mango).

- Escoba abierta: 160cm (longitud total con mango).
- Dientes planos.

Ref.	Medidas	EAN	unid.	PVP
S143	Abertura de 19 a 55cm	5602796000094	12	16,27 €

ESCOBA JARDÍN



- Regulable con mango extensible
- Cuerpo metálico.
- Empuñadura superior de plástico.

- Escoba con 15 palos de metal.
- Escoba cerrada: 19cm (ancho).
- Escoba abierta: 50cm (ancho).

- Escoba cerrada: 80cm (longitud total con mango cerrado).
- Escoba abierta: 160cm (longitud total con mango abierto).
- Dientes planos.

Ref.	Medidas	EAN	unid.	PVP
S1585	Abertura de 19 a 50cm	5602796006331	12	17,29 €

ESCOBA JARDÍN



- Cuerpo metálico regulable.
- 22 dientes.
- Dientes planos.

Ref.	Medidas	EAN	unid.	PVP
S2067	Sin mango	5602796012424	6	11,21 €
S2067CJ	Con mango de madera	5602796052680	6	15,14 €

ESCOBA JARDÍN



- Polipropileno Triangular
- 20 dientes.
- Ancho: 45cm.
- Dientes planos.

Ref.	Medidas	EAN	unid.	PVP
S3457- 20	Sin mango	5602796050242	12	7,91 €
S3457-20C	Con mango de madera	5602796053298	12	12,08 €

CALZADO DE SEGURIDAD FUSIÓN

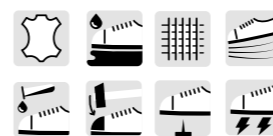

- Microfibra resistente y duradero
- Suela antipinchazos, con plantilla en Kevlar.
- Suela preparada para absorción de impactos.
- Puntera resistente en compuesto.
- Suela antideslizante resistente al aceite.
- Forro transpirable y antibacteriano.
- Suela de poliuretano anti estático.
- Suela de poliuretano resistente a los ácidos



Ref.	Medidas	EAN	unid.	PVP
S3592-36	Nº 36	5602796057364	10	63,32 €
S3592-37	Nº 37	5602796057371	10	63,32 €
S3592-38	Nº 38	5602796057388	10	63,32 €
S3592-39	Nº 39	5602796057395	10	63,32 €
S3592-40	Nº 40	5602796057401	10	63,32 €
S3592-41	Nº 41	5602796057418	10	63,32 €
S3592-42	Nº 42	5602796057425	10	63,32 €
S3592-43	Nº 43	5602796057432	10	63,32 €
S3592-44	Nº 44	5602796057449	10	63,32 €
S3592-45	Nº 45	5602796057456	10	63,32 €
S3592-46	Nº 46	5602796057463	10	63,32 €

CALZADO DE SEGURIDAD MAKER

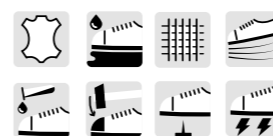

- Microfibra resistente y duradero
- Suela antipinchazos, con plantilla en Kevlar.
- Suela preparada para absorción de impactos.
- Puntera resistente en compuesto.
- Suela antideslizante resistente al aceite.
- Forro transpirable y antibacteriano.
- Suela de poliuretano anti estático.
- Suela de poliuretano resistente a los ácidos



Ref.	Medidas	EAN	unid.	PVP
S3608-36	Nº 36	5602796057739	10	49,27 €
S3608-37	Nº 37	5602796057746	10	49,27 €
S3608-38	Nº 38	5602796057753	10	49,27 €
S3608-39	Nº 39	5602796057760	10	49,27 €
S3608-40	Nº 40	5602796057777	10	49,27 €
S3608-41	Nº 41	5602796057784	10	49,27 €
S3608-42	Nº 42	5602796057791	10	49,27 €
S3608-43	Nº 43	5602796057807	10	49,27 €
S3608-44	Nº 44	5602796057814	10	49,27 €
S3608-45	Nº 45	5602796057821	10	49,27 €
S3608-46	Nº 46	5602796057838	10	49,27 €

CALZADO DE SEGURIDAD CARBÓN

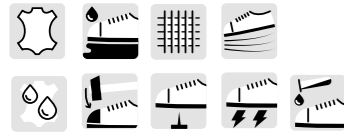

- Piel genuina, dura y duradera.
- Suela antipinchazos, con plantilla en Kevlar.
- Suela preparada para absorción de impactos.
- Puntera resistente en compuesto.
- Suela antideslizante resistente al aceite.
- Resistente a la penetración del agua.
- Forro transpirable y antibacteriano.
- Suela de poliuretano anti estático.
- Suela de poliuretano resistente a los ácidos



Ref.	Medidas	EAN		unid.	PVP
S3587-36	Nº 36	5602796061507		10	61,94 €
S3587-37	Nº 37	5602796061408		10	61,94 €
S3587-38	Nº 38	5602796061415		10	61,94 €
S3587-39	Nº 39	5602796061422		10	61,94 €
S3587-40	Nº 40	5602796061439		10	61,94 €
S3587-41	Nº 41	5602796061446		10	61,94 €
S3587-42	Nº 42	5602796061453		10	61,94 €
S3587-43	Nº 43	5602796061460		10	61,94 €
S3587-44	Nº 44	5602796061477		10	61,94 €
S3587-45	Nº 45	5602796061484		10	61,94 €
S3587-46	Nº 46	5602796061491		10	61,94 €

BOTAS DE SEGURIDAD ADVENTURE

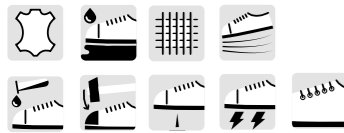

- Gamuza genuina, resistente y durable.
- Suela antipinchazos, con plantilla en Acero.
- Suela preparada para absorción de impactos.
- Puntera resistente en acero
- Suela antideslizante resistente al aceite.
- Agujeros en los cordones reforzado con aros metálico.
- Forro transpirable y antibacteriano.
- Suela de poliuretano anti estático.
- Suela de poliuretano resistente a los ácidos



Ref.	Medidas	EAN		unid.	PVP
S3508-36	Nº 36	5602796052185		10	64,50 €
S3508-37	Nº 37	5602796052192		10	64,50 €
S3508-38	Nº 38	5602796052208		10	64,50 €
S3508-39	Nº 39	5602796052215		10	64,50 €
S3508-40	Nº 40	5602796052222		10	64,50 €
S3508-41	Nº 41	5602796052239		10	64,50 €
S3508-42	Nº 42	5602796052246		10	64,50 €
S3508-43	Nº 43	5602796052253		10	64,50 €
S3508-44	Nº 44	5602796052260		10	64,50 €
S3508-45	Nº 45	5602796052277		10	64,50 €
S3508-46	Nº 46	5602796052284		10	64,50 €

GUANTES DE PROTECCIÓN



- Antideslizante
- Revestimiento de látex.
- Malla de poliéster.

Ref.	Medidas	EAN		unid.	PVP
S3489-9	Nº 9	5602796051324		12	3,09 €
S3489-10	Nº 10	5602796051331		12	3,09 €

GUANTES DE PROTECCIÓN



- Recubrimiento de látex rugoso.
- Malla de poliéster.

Ref.	Medidas	EAN		unid.	PVP
S2548/9	Nº 9	5602796019959		12	2,13 €
S2548/10	Nº 10	5602796020917		12	2,13 €

GUANTES DE PROTECCIÓN



- Nitrilo gris
- Recubrimiento de nitrilo.
- Malla de poliéster.

Ref.	Medidas	EAN		unid.	PVP
S1800/1	Nº 9	5602796014466		12	1,40 €
S1800/10	Nº 10	5602796031753		12	1,40 €

GUANTES DE PROTECCIÓN



- Antideslizante
- Recubrimiento de látex y puntos de nitrilo.
- Malla de nylon y elastano.

Ref.	Medidas	EAN		unid.	PVP
S3490-9	Nº 9	5602796051362		12	2,84 €
S3490-10	Nº 10	5602796051379		12	2,84 €

GUANTES DE PROTECCIÓN



- Ultrafino
- Recubrimiento de poliuretano.
- Malla de poliéster.

Ref.	Medidas	EAN		unid.	PVP
S2793	Nº 9	5602796034266		12	1,33 €
S2794	Nº 10	5602796034273		12	1,33 €

GUANTES DE PROTECCIÓN



- Recubrimiento de látex rugoso.
- Malla de polialgodón.

Ref.	Medidas	EAN		unid.	PVP
S232/S/COSTURAS	Nº 9	5602796014459		12	2,68 €
S232/S/COST-10	Nº 10	5602796020931		12	2,68 €

GUANTES DE PROTECCIÓN



- Recubrimiento de nitrilo.
- Malla de Algodón.
- Puño Elástico.

Ref.	Medidas	EAN	unid.	PVP
S231/TAPA	Nº 9	5602796032330	12	2,94 €
S231/TAPA 10	Nº 10	5602796032347	12	2,94 €

GUANTES DE PROTECCIÓN



- En Nitrilo, 2 Baños
- Revestimiento con 2 baños de nitr
- Malla de Algodón.

Ref.	Medidas	EAN	unid.	PVP
S231/9	Nº 9	5602796006874	12	2,94 €
S231	Nº 10	5602796002203	12	2,94 €

GUANTES DE PROTECCIÓN



- En Cuero Vacuno Natural
- Puño ancho

Ref.	Medidas	EAN	unid.	PVP
S228/B-9	Nº 9	5602796034655	12	3,12 €
S228/B-10	Nº 10	5602796021242	12	3,12 €

GUANTES DE PROTECCIÓN PARA ALTAS TEMPERATURAS



- Crudo reforzado
- Puño ancho

Ref.	Medidas	EAN	unid.	PVP
S232	Nº 10	5602796002210	12	4,62 €

GUANTES DE PROTECCIÓN



- Recubrimiento de nitrilo.
- Puño ancho.

Ref.	Medidas	EAN	unid.	PVP
S2726	Nº 10	5602796046610	12	2,01 €

GUANTES DE PROTECCIÓN



- En Nitrilo, 1 Baño
- Revestimiento con 1 baño de nitr
- Malla de Algodón.

Ref.	Medidas	EAN	unid.	PVP
S1663/9	Nº 9	5602796014442	12	1,65 €
S1663/10	Nº 10	5602796014916	12	1,65 €

GUANTES DE PROTECCIÓN PARA ALTAS TEMPERATURAS



- Para soldador
- Guantes crudos con fo

Ref.	Medidas	EAN	unid.	PVP
S2807	-	5602796037885	12	5,46 €

COMPRESORES SILENCIOSOS



- Potencia: 0,75Kw / 1Cv.
- Cadena: 3.5A.

- Voltaje: 230V.
- Rotación: 1380 rpm.

- Frecuencia: 50 Hz.
- Flujo de aire: 130L/min.

- Motor sin aceite.
- Presión max: 8 Bar.

- Trabajo: Silencioso.
- Salida: Unión Rápida.

Ref.	Medidas	EAN	unid.	PVP
S3627-6	6 L	5602796061811	1	217,50 €
S3627-24	24 L	5602796059115	1	245,70 €
S3627-50	50 L	5602796059122	1	317,97 €

LIMPIADORA ALTA PRESIÓN HP2

PVP: 325,22 €



- Motor de inducción.
- Sistema Smart Start and Stop.
- Bomba de 3 pistones.
- Sistema de protección térmica TPS.
- Filtro de agua.
- Pistola de montaje rápido.
- Depósito detergente
- Potencia: 2200 W
- Presión max: 160 Bar
- Caudal: 5,6 l/min.
- Manguera de 5m con refuerzo de malla de acero
- Acc: Lanza y lanza turbo.



Ref.	Info	EAN	unid.
3734-160	160B	5602796062801	1

LIMPIADORA ALTA PRESIÓN HP4

PVP: 494,20 €



- Motor de inducción.
- Sistema Smart Start and Stop.
- Bomba de 3 pistones.
- Sistema de protección térmica TPS.
- Filtro de agua.
- Manguera de 8m con refuerzo de malla de acero.
- Carrete para manguera
- Depósito detergente
- Potencia: 2500 W
- Presión max: 170 Bar
- Caudal: 7,3 l/min.
- Acc: Lanza y lanza turbo.



Ref.	Info	EAN	unid.
3734-170	170B	5602796062818	1





INGCO

Professional Tools

www.ingco.es

WZAROS
POWER FOR WARRIORS

 **SERFER**[®]

ALMACÉN CENTRAL Y OFICINAS

Cami dels Frares 41 - 43,
25190 Lleida - 973 200 527

RAZÓN SOCIAL:

WTCZ, Avda. María Zambrano, 31
(Torre Oeste) Planta 15 - 50018 - Zaragoza

ADMINISTRACIÓN:

info@ingco.es

PEDIDOS:

pedidos@ingco.es

SERVICIO TÉCNICO:

sat@ingco.es

